



Plasmid DNA purification

User manual

NucleoSpin[®] 96 Plasmid
NucleoSpin[®] 96 Plasmid Core Kit

November 2016 / Rev. 04

Table of contents

1	Components	4
1.1	Kit contents	4
1.2	Reagents to be supplied by user	5
2	Product description	6
2.1	The basic principle	6
2.2	Kit specifications	6
2.3	Required hardware	7
2.4	Recommended accessories for use of the NucleoSpin® 96 Plasmid Core Kit	8
2.5	Automated processing on robotic platforms	9
2.6	Growth of bacterial cultures	9
2.6.1	Selection of culture media	9
2.6.2	Cultivation of bacteria in a Square-well Block	9
2.6.3	Cultivation of bacteria in tubes	10
2.7	Elution procedures	11
3	Storage conditions and preparation of working solutions	12
4	Safety instructions	13
5	Protocols	15
5.1	NucleoSpin® 96 Plasmid – manual vacuum processing	15
5.2	NucleoSpin® 8 Plasmid – elution of DNA using a centrifuge	24
6	Appendix	24
6.1	Troubleshooting	24
6.2	Ordering information	26
6.3	Product use restriction / warranty	29

1 Components

1.1 Kit contents

NucleoSpin® 96 Plasmid			
REF	1 x 96 preps 740625.1	4 x 96 preps 740625.4	24 x 96 preps ¹ 740625.24
Resuspension Buffer A1	75 mL	150 mL	6 x 150 mL
Lysis Buffer A2	75 mL	150 mL	6 x 150 mL
Neutralization Buffer A3	100 mL	200 mL	6 x 200 mL
Wash Buffer AW	100 mL	400 mL	6 x 400 mL
Wash Buffer A4 (Concentrate) ²	100 mL	200 mL	6 x 200 mL
Elution Buffer AE ³	30 mL	125 mL	6 x 125 mL
RNase A (lyophilized) ²	30 mg	60 mg	6 x 60 mg
NucleoSpin® Plasmid Binding Plate (white rings)	1	4	24
NucleoSpin® Plasmid Filter Plate (violet rings)	1	4	24
Culture Plate (including Gas-permeable Foil)	1	4	24
Elution Plate (including Self-adhering Foil)	1	4	24
MN Wash Plate	1	4	24
User manual	1	1	6

¹ The kit for 24 x 96 preparations (REF 740625.24) consists of 6 x REF 740625.4.

² For preparation of working solutions and storage conditions see section 3.

³ Composition of Elution Buffer AE: 5 mM Tris/HCl, pH 8.5

Kit contents (continued)

REF	NucleoSpin® 96 Plasmid Core Kit	
	4 x 96 preps 740616.4	24 x 96 preps ¹ 740616.24
Resuspension Buffer A1	150 mL	6 x 150 mL
Lysis Buffer A2	150 mL	6 x 150 mL
Neutralization Buffer A3	200 mL	6 x 200 mL
Wash Buffer A4 Concentrate) ²	2 x 100 mL	12 x 100 mL
Elution Buffer AE ³	125 mL	6 x 125 mL
RNase A (lyophilized) ²	60 mg	6 x 60 mg
NucleoSpin® Plasmid Binding Plate (white rings)	4	24
NucleoSpin® Plasmid Filter Plate (violet rings)	4	24
User manual	1	6

1.2 Reagents to be supplied by user

- 96–100 % ethanol

¹ The kit for 24 x 96 preparations (REF 740616.24) consists of 6 x REF 740616.4.

² For preparation of working solutions and storage conditions see section 3.

³ Composition of Elution Buffer AE: 5 mM Tris/HCl, pH 8.5

2 Product description

2.1 The basic principle

The **NucleoSpin® 96 Plasmid** procedure is a modified version of the Birnboim and Doly¹ alkaline lysis plasmid Mini prep protocol. Bacterial cultures are harvested by an initial centrifugation step. After resuspension of the pelleted bacteria (Buffer A1) and alkaline cell lysis (Buffer A2), a neutralization and binding buffer (Buffer A3) containing chaotropic salts is added. Resulting bacterial crude lysates are cleared by vacuum filtration with the NucleoSpin® Plasmid Filter Plate. The cleared lysates containing the plasmid DNA are collected into the NucleoSpin® Plasmid Binding Plate. The chaotropic salt leads to a reversible adsorption of the plasmid DNA to the NucleoSpin® silica membrane during the second vacuum-filtration step. High purity of the final plasmid DNA preparation is achieved by complete removal of cellular contaminants, salts, detergents, and other compounds by subsequent washing steps. Highly pure plasmid DNA is finally eluted with Elution Buffer AE (5 mM Tris/HCl, pH 8.5) or water (pH 8.0–8.5) and can directly be used for downstream applications.

2.2 Kit specifications

- **NucleoSpin® 96 Plasmid** is designed for the manual or automated large-scale purification of high-copy plasmid DNA from *E. coli* in the 96-well plate format.
- **NucleoSpin® 96 Plasmid** kits (REF 740625.1/.4/.24) are supplied with all accessory plates for highest convenience.
- The **NucleoSpin® 96 Plasmid Core Kit** (REF 740616.4/.24) provides the buffers, RNase A, NucleoSpin® Plasmid Filter Plates, and NucleoSpin® Plasmid Binding Plates. Accessory components (e.g., culture plate, elution plate, MN Wash Plate, and Wash Buffer AW) are not provided with the core kit but can be individually selected from a variety of suitable accessories (see section 2.4 for further information). This allows highest flexibility for the user.
Please note: All given specifications or information in this manual refer equally to the **NucleoSpin® 96 Plasmid** kit (REF 740625.1/.4/.24) as well as to the **NucleoSpin® 96 Plasmid Core Kit** (REF 740616.4/.24).
- The kits allow for easy automation on common liquid handling instruments. For more information about the automation process and the availability of ready-to-run scripts for certain platforms please refer to section 2.5 and/or contact your local distributor or MN directly.
- Using the **NucleoSpin® 96 Plasmid** kits allow simultaneous manual processing of up to 96 samples typically within less than 45 minutes. Actual processing time depends on the configuration of the liquid handling system used.
- Typically yields of 5–15 µg plasmid DNA can be purified from 1.5 mL overnight cultures.
- Yield depends on copy number and plasmid size, selected culture medium, and bacterial host strain.

¹ Birnboim, H.C. & Doly, J. (1979) *Nucleic Acids Res.* 7, 1513-1523.

- The DNA binding capacity is about 20 µg. The final concentration of the eluted DNA is 50–200 ng/µL (depending on the elution buffer volume and the bacterial culture).
- Typically, the A_{260}/A_{280} ratio is > 1.8. Eluted DNA is ready to use for many downstream applications.

Table 1: Kit specifications at a glance

Parameter	NucleoSpin® 96 Plasmid
Format	96-well plates
Processing	Manual or automated, vacuum
Lysate clarification	96-well filter plates
Sample material	1–5 mL <i>E. coli</i> culture
Vector size	< 15 kbp
Typical yield	4–6 µg/mL <i>E. coli</i> culture
Elution volume	75–150 µL
Preparation time	45 min/plate
Binding capacity	20 µg

2.3 Required hardware

This kit is intended for use under vacuum. A support protocol for elution under centrifugation is included (see section 5.2).

A support protocol for complete processing under centrifugation is available from our technical service (tech-bio@mn-net.com).



The **NucleoSpin® 96 Plasmid** kits can be used **manually** with the NucleoVac 96 Vacuum Manifold (see ordering information, section 6.2). Additionally, a suitable centrifuge for harvesting the bacteria (either plate or tube centrifuge) and for the optimal elution step under centrifugation is required.

2.4 Recommended accessories for use of the NucleoSpin® 96 Plasmid Core Kit

The **NucleoSpin® 96 Plasmid Core Kit** provides buffers (except optional Wash Buffer AW), RNase A, and NucleoSpin® Filter/Binding Plates. Accessory plates (e.g., culture blocks, elution plates) are not provided with the core kit. The user can individually select additional consumables from a variety of suitable accessory plates according to his requirements for highest flexibility.

For use of **NucleoSpin® 96 Plasmid Core Kit**, follow the standard protocols (see section 5.1 or 5.2, respectively).

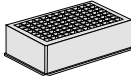
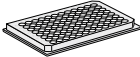
Recommended accessories for use of the **NucleoSpin® 96 Plasmid Core Kit** are available from MACHEREY-NAGEL. For ordering information, please refer to section 6.2.

Protocol step	Suitable consumables, not supplied with the core kits	Remarks
1. Cultivation of bacteria	Culture Plates 	Square-well Blocks with Gas-permeable Foil
9. Wash step	MN Wash Plates  Buffer AW	MN Wash Plate minimizes the risk of cross contamination (vacuum processing only) Recommended additional wash buffer for bacterial host strain with high endogenous nuclease activity (e.g., <i>E. coli</i> HB 101, BMH 71-18 mutS, JM, or any wildtype strains) or for improvement of sequencing results
13. Elution	Elution Plate U-bottom  or Rack of Tube Strips (including Cap Strips) 	Not suitable for elution by centrifugation

2.5 Automated processing on robotic platforms

NucleoSpin® 96 Plasmid can be used fully automated on many common laboratory workstations. For the availability of scripts and general considerations about adapting **NucleoSpin® 96 Plasmid** on a certain workstation, please contact MN. Full processing under vacuum enables complete automation without the need of centrifugation steps, regarding the drying of the binding membrane and elution step.

The risk of cross-contamination is reduced by optimized vacuum settings during the elution step and by the improved shape of the outlets of the NucleoSpin® Plasmid Binding Plate.

Drying of the NucleoSpin® Plasmid Binding Plate under vacuum is sufficient because the bottom of the plate is protected from residues of wash buffer during the washing steps by the MN Wash Plate. As a result, we recommend trying to integrate the MN Wash Plate into the automated procedure. The MN Frame (see ordering information) can be used to position the disposable MN Wash Plate inside the vacuum chamber. This also reduces the risk of cross-contamination, as common metal adaptors tend to get contaminated by gDNA. Thorough cleaning of the vacuum chamber is recommended after each run to prevent forming of gDNA-containing aerosols.

Visit MN online at www.mn-net.com or contact your local MACHEREY-NAGEL distributor for technical support regarding hardware, software, setup instructions, and selection of the protocol. Several application notes of the **NucleoSpin® 96 Plasmid** kit on various liquid handling instruments can also be found at www.mn-net.com under Bioanalysis/Literature.

2.6 Growth of bacterial cultures

2.6.1 Selection of culture media

The cultivation of cells is recommended at 37 °C in LB (Luria-Bertani) medium at constant shaking (200–250 rpm). Alternatively, rich media like 2 x YT or TB (Terrific Broth) can be used. By using 2 x YT or TB, bacteria grow faster and reach the stationary phase much earlier than in LB medium (≤ 12 h) in culture tubes or flasks. This may lead to a higher percentage of dead or starving cells when starting the preparation. The resulting plasmid DNA from overgrown cultures may be partially degraded or contaminated with chromosomal DNA.

2.6.2 Cultivation of bacteria in a Square-well Block

Use the 96-well Square-well Block (Culture Plate; not included in the core kits) for growing bacteria. Add 1.2–1.5 mL of selected medium (with appropriate antibiotic, e.g., 100 µg/mL ampicillin) to each well of the Square-well Block. To avoid cross-contamination due to spillage during incubation, do not exceed a total culture volume of 1.5 mL. Inoculate each well with a single bacterial colony. Cover the Square-well Block with the Gas-permeable Foil. Grow the culture in a suitable incubator at 37 °C for 16–24 h with vigorous shaking (200–400 rpm). The Square-well Block may be fixed to the shaker with large-size flask clamps (for 2-L flasks) or tape.

Note: The yield of plasmid DNA depends on growth conditions, bacterial strain, and cell density of the culture as well as on the size and copy number of the vector. Use of high-copy number plasmids such as pUC, pBluescript, or pGEM and E. coli strains like DH5 α or XL1 Blue are recommended. Growth times of 16–24 h are usually sufficient. However, for poorly growing bacteria, prolonged incubation times of up to 30 h may be required.

2.6.3 Cultivation of bacteria in tubes

Use 1–5 mL of appropriate culture medium. Depending on the bacterial strain and copy number of the plasmid, up to 5 mL LB medium or 2.5 mL 2 x YT or 2.5 mL TB medium can be used. Grow bacteria with vigorous shaking (200–250 rpm) for 10–14 h.

Optional: If the liquid handling instrument does not allow for the use of selected culture tubes, transfer the bacterial culture from the tubes into a suitable Square-well Block. For this, transfer 1.5 mL of the culture to each well of the Square-well Block. Harvest the cultures by centrifugation. Discard supernatant. Usually 1.5 mL of culture are sufficient for DNA preparation. However, if necessary, add additional 1.0–1.5 mL bacterial culture to each well of the Square-well Block, centrifuge again, and discard the supernatant.

Do not use more than 5 mL LB culture or 2.5 mL rapid growing bacterial strain (using 2 x YT or TB medium) because lysis efficiency might be lower when using cell pellets which are too large.

2.7 Elution procedures

See the following table for correlation between the dispensed elution buffer volume and typical recoveries following the standard protocol under vacuum.

The recommended dispense volume of elution buffer is 125 μL .

Table 2: Correlation between dispensed elution buffer volume and typical recovery

Dispensed elution buffer	75 μL	100 μL	125 μL	150 μL	175 μL
Recovered elution buffer containing PCR-products	30 \pm 5 μL	55 \pm 5 μL	80 \pm 5 μL	105 \pm 5 μL	130 \pm 5 μL

- ◆ Concentration, ng/ μL
- Recovered DNA, μg
- ▲ Recovery, %

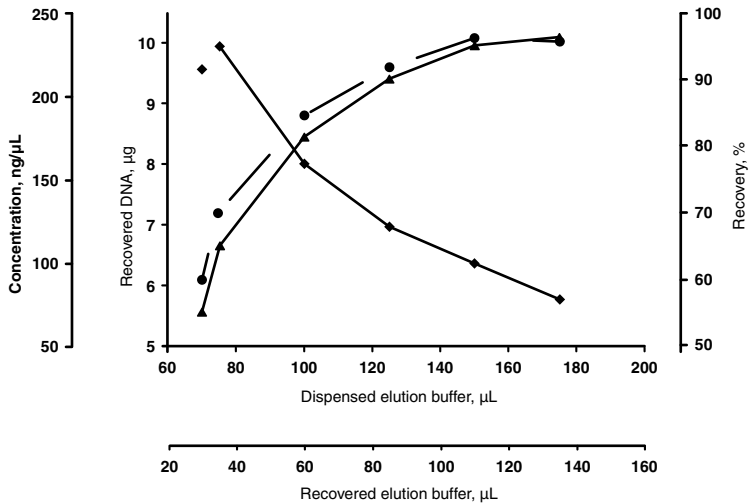

Figure 1 Recovery rate and concentration depend on elution volume.

10 μg of pBluescript plasmid were purified with NucleoSpin[®] 96 Plasmid and eluted with the indicated elution buffer volumes.

3 Storage conditions and preparation of working solutions

Attention: Buffers A3 and AW contain chaotropic salts which are irritant. Buffer A2 contains SDS and sodium hydroxide which are irritant and hazardous. Wear gloves and goggles!

CAUTION: Buffers A3 and AW contain guanidine hydrochloride which can form highly reactive compounds when combined with bleach (sodium hypochlorite). DO NOT add bleach or acidic solutions directly to the sample-preparation waste.

Storage conditions:

- All kit components can be stored at room temperature (18–25 °C) and are stable up to one year. Always keep buffer bottles tightly closed, especially if buffers are preheated during the preparation. Sodium dodecyl sulfate (SDS) in Buffer A2 may precipitate if stored at temperatures below 20 °C. If a precipitate is observed in Buffer A2, incubate the bottle at 30–40 °C for several minutes and mix well.

Before starting any **NucleoSpin® 96 Plasmid** protocol, prepare the following:

- Before the first use of the kit, add 1 mL of **Buffer A1** to the **RNase A** vial and vortex. Transfer all of the resulting solution into the Buffer A1 bottle and mix thoroughly. Indicate date of RNase A addition. Store Buffer A1 containing RNase A at 4 °C. The solution will be stable at this temperature for at least six months.
- Wash Buffer A4:** Add the indicated volume of ethanol (96–100%) to Buffer A4 Concentrate before use. Mark the label of the bottle to indicate that ethanol was added.

NucleoSpin® 96 Plasmid			
REF	1 x 96 preps 740625.1	4 x 96 preps 740625.4	24 x 96 preps 740625.24
Wash Buffer A4 (Concentrate)	100 mL Add 400 mL ethanol	200 mL Add 800 mL ethanol to each bottle	6 x 200 mL Add 800 mL ethanol to each bottle

NucleoSpin® 96 Plasmid Core Kit		
REF	4 x 96 preps 740616.4	24 x 96 preps 740616.24
Wash Buffer A4 (Concentrate)	2 x 100 mL Add 400 mL ethanol to each bottle	12 x 100 mL Add 400 mL ethanol to each bottle





4 Safety instructions

The following components of the **NucleoSpin® 96 Plasmid (Core Kit)** kits contain hazardous contents.

Wear gloves and goggles and follow the safety instructions given in this section.

GHS classification

Only harmful features do not need to be labeled with H and P phrases up to 125 mL or 125 g. *Mindergefährliche Eigenschaften müssen bis 125 mL oder 125 g nicht mit H- und P-Sätzen gekennzeichnet werden.*

Component	Hazard contents	GHS symbol	Hazard phrases	Precaution phrases
<i>Inhalt</i>	<i>Gefahrstoff</i>	<i>GHS-Symbol</i>	<i>H-Sätze</i>	<i>P-Sätze</i>
A2	Sodium hydroxide solution 0.5–1.0 % <i>Natriumhydroxid-Lösung</i> 0,5–1,0 % CAS 1310-73-2-84-0	 WARNING ACHTUNG	315, 319	264, 280, 302+352, 305+351+338, 332+313, 337+313
A3	Guanidinium hydrochloride 36–50 % <i>Guanidinhydrochlorid 36–50 %</i> CAS 50-01-1	 WARNING ACHTUNG	302, 319	264, 280, 301+312, 305+351+338, 330, 337+313
AW	Guanidinium hydrochloride 36–50 % and 2-propanol 20–50 % <i>Guanidinhydrochlorid 36–50 %</i> <i>und 2-Propanol 20–50 %</i> CAS 50-01-1	 WARNING ACHTUNG	226, 302, 319, 336	210, 233, 264, 280, 301+312, 305+351+338, 330, 337+313, 370+378, 403+235
RNase A	RNase 90–100 % <i>RNase 90–100 %</i> CAS 9001-99-4	 DANGER GEFAHR	317, 334	261, 272, 280, 302+352, 304+340, 333+313, 342+311, 363

Hazard phrases

H 226	Flammable liquid and vapour. <i>Flüssigkeit und Dampf entzündbar.</i>
H 302	Harmful if swallowed. <i>Gesundheitsschädlich bei Verschlucken.</i>
H 315	Causes skin irritation. <i>Verursacht Hautreizungen.</i>
H 317	May cause an allergic skin reaction. <i>Kann allergische Hautreaktionen verursachen.</i>
H 319	Causes serious eye irritation. <i>Verursacht schwere Augenreizung.</i>

H 334 May cause allergy or asthma symptoms or breathing difficulties if inhaled.
Kann bei Einatmen Allergie, asthmaartige Symptome oder Atembeschwerden verursachen.

H 336 May cause drowsiness or dizziness.
Kann Schläfrigkeit und Benommenheit verursachen.

Precaution phrases

P 210 Keep away from heat, hot surfaces, sparks, open flames and other ignition sources. No smoking.
Von Hitze, heißen Oberflächen, Funken, offenen Flammen sowie anderen Zündquellenarten fernhalten. Nicht rauchen.

P 233 Keep container tightly closed.
Behälter dicht verschlossen halten.

P 264 Wash ... thoroughly after handling.
Nach Handhabung ... gründlich waschen.

P 301+312 IF SWALLOWED: Call a POISON CENTER / doctor / ... / if you feel unwell.
BEI VERSCHLUCKEN: Bei Unwohlsein GIFTINFORMATIONSZENTRUM/Arzt/... anrufen.

P 302+352 IF ON SKIN: Wash with plenty of water / ...
BEI BERÜHRUNG MIT DER HAUT: Mit viel Wasser/... waschen.

P 304+340 IF INHALED: Remove person to fresh air and keep comfortable for breathing.
BEI EINATMEN: Die Person an die frische Luft bringen und für ungehinderte Atmung sorgen.

P 305+351+338 IF IN EYES: Rinse cautiously with water for several minutes. Remove contact lenses, if present and easy to do. Continue rinsing.
BEI KONTAKT MIT DEN AUGEN: Einige Minuten lang behutsam mit Wasser ausspülen. Eventuell vorhandene Kontaktlinsen nach Möglichkeit entfernen. Weiter ausspülen.

P 330 Rinse mouth.
Mund ausspülen.

P 332+313 If skin irritation occurs: Get medical advice / attention.
Bei Hautreizung: Ärztlichen Rat einholen / ärztliche Hilfe hinzuziehen.

P 333+313 If skin irritation or rash occurs: Get medical advice/attention.
Bei Hautreizung oder -ausschlag: Ärztlichen Rat einholen/ärztliche Hilfe hinzuziehen.

P 337+313 If eye irritation persists: Get medical advice / attention.
Bei anhaltender Augenreizung: Ärztlichen Rat einholen/ärztliche Hilfe hinzuziehen.

P 342+311 If experiencing respiratory symptoms: Call a POISON CENTER / doctor / ...
Bei Symptomen der Atemwege: GIFTINFORMATIONSZENTRUM/Arzt/... anrufen.

P 363 Wash contaminated clothing before reuse.
Kontaminierte Kleidung vor erneutem Tragen waschen.

P 370+378 In case of fire: Use ... to extinguish.
Bei Brand: ... zum Löschen verwenden.

P 403+235 Store in a well-ventilated place. Keep cool.
An einem gut belüfteten Ort aufbewahren. Kühl halten.

For further information please see Material Safety Data Sheets (www.mn-net.com).
Weiterführende Informationen finden Sie in den Sicherheitsdatenblättern (www.mn-net.com).



The symbol shown on labels refers to further safety information in this section.
Das auf Etiketten dargestellte Symbol weist auf weitere Sicherheitsinformationen dieses Kapitels hin.

5 Protocols

5.1 NucleoSpin® 96 Plasmid – manual vacuum processing

- For hardware requirements, refer to section 2.3.
- For detailed information regarding the vacuum manifold setup, see page 17 and 18.
- For detailed information on each step, see page 19.
- For use of the NucleoSpin® 96 Plasmid Core Kit (REF 740616.4 / .24), refer to section 2.4 regarding recommended accessories.

Before starting the preparation:

- Check if Buffer A1 and Buffer A4 were prepared according to section 3.
- Set up the vacuum according to the scheme.

Protocol-at-a-glance

1	Cultivate and harvest bacterial cells	1.5 mL–5 mL LB or up to 2.5 mL 2 x YT or TB 10 min, 1,000 x g
2	Resuspend bacterial cells	250 µL A1 Mix or shake
3	Lyse bacterial cells	250 µL A2 RT, 2–5 min Shake
4	Neutralize	350 µL A3 Mix or shake
Prepare vacuum manifold for lysate clearing step		
5	Transfer crude lysates to NucleoSpin® Plasmid Filter Plate (violet rings)	
6	Clear crude lysates by vacuum filtration directly into the NucleoSpin® Plasmid Binding Plate (white rings) <i>Optional: Incubate 1–3 min before applying vacuum</i>	-0.2 to -0.4 bar*, 1–5 min

* Reduction of atmospheric pressure

7	Reassemble vacuum manifold Discard NucleoSpin® Plasmid Filter Plate Remove NucleoSpin® Plasmid Binding Plate with cleared lysates and insert MN Wash Plate Place NucleoSpin® Plasmid Binding Plate on top of the manifold	
8	Bind DNA to silica membrane of the NucleoSpin® Plasmid Binding Plate by applying vacuum	-0.2 to -0.4 bar*, 1 min
9	Wash silica membrane	(Optional: 600 µL AW) 900 µL A4 900 µL A4 -0.2 to -0.4 bar*, 1 min each step
10	Remove MN Wash Plate	
11	Dry NucleoSpin® Plasmid Binding Plate by applying vacuum <i>Optional: Dry the outlets of the NucleoSpin® Plasmid Binding Plate by placing it on a sheet of filter paper before applying vacuum</i>	Full vacuum 10–15 min (run pump continuously)*
12	Insert Elution Plate U-bottom	
13	Elute plasmid DNA <i>Optional: Incubate 1–3 min</i>	75–150 µL AE -0.4 to -0.6 bar*, 1 min

* Reduction of atmospheric pressure

Setup of vacuum manifold: Lysate clearing

Lysate clearing

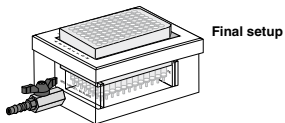
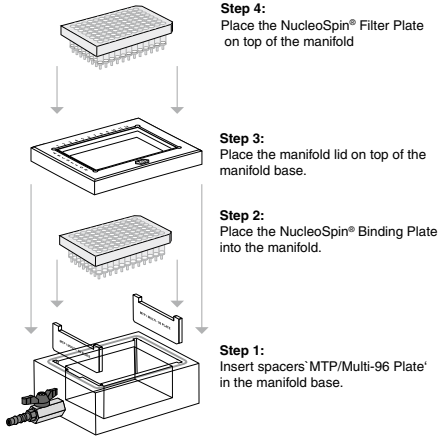

Setup of vacuum manifold: Binding/Washing/Elution steps

Binding / Washing steps

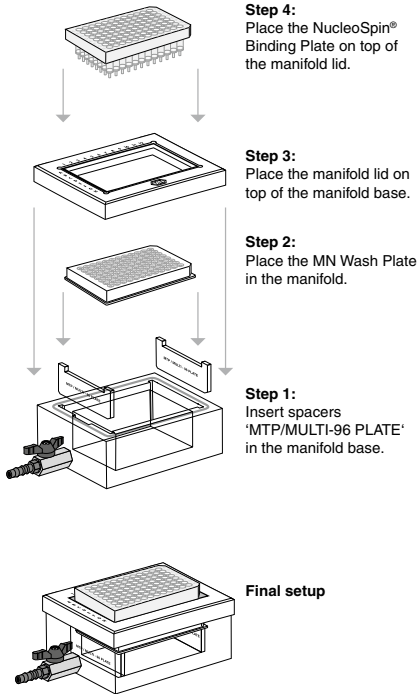

Elution step

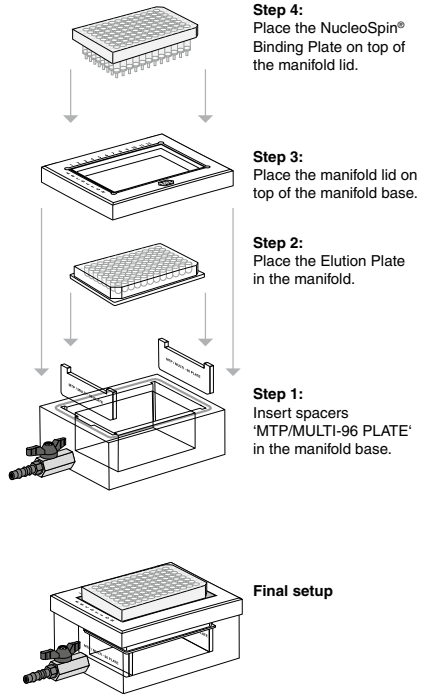

Detailed protocol

For processing of **NucleoSpin® 96 Plasmid** under vacuum the NucleoVac 96 Vacuum Manifold is required.

Before starting the preparation:

- Check if Buffer A1 and Buffer A4 were prepared according to section 3.
-

1 Cultivate and harvest bacterial cells

Centrifuge the bacteria cultures (1.5–5 mL LB or up to 2.5 mL 2 x YT or TB) for **10 min at 1,000 x g**.

It is highly recommended centrifuging the bacterial cultures under the above mentioned conditions. Centrifugation at higher *g*-forces might produce tight pellets which are more difficult to resuspend.

Discard supernatant. Remove residual medium by tapping tube or plate upside down on a clean paper sheet or soft tissue.

Optional: Transfer bacteria cultures grown in tubes to a Square-well Block. Alternatively, perform the next three steps in the tubes.

2 Resuspend bacterial cells

Add **250 µL Buffer A1 with RNase A** to each sample. Resuspend the bacterial pellet by vortexing or mixing by pipetting up and down. Resuspend bacterial cells completely. No clumps should be visible.

3 Lyse bacterial cells

Add **250 µL Buffer A2** to the suspension. (For lysis in tubes: close the culture tube and mix by inverting several times.)

Incubate at **room temperature (18–25 °C)** for a maximum of **5 min** with moderate shaking (300 rpm).

Note: Do not vortex; doing so will release contaminating chromosomal DNA from the cellular debris into the suspension. Do not allow the lysis reaction to proceed for more than 5 minutes.

4 Neutralize

Add **350 µL Buffer A3** to the suspension. (For lysis in tubes: close the culture tube and mix by inverting several times. For lysis in plates: either mix by pipetting up and down after addition of Buffer A3 or before loading to NucleoSpin® Plasmid Filter Plate.)

Optional: Incubate on ice for 5 min for optimal formation of precipitate.

Prepare the NucleoVac 96 Vacuum Manifold

Prepare manifold for filtration of crude lysates (see page 17):

Insert spacers labeled 'MTP/Multi-96 Plate' notched side up into the grooves located on the short sides of the manifold base. Insert waste container into manifold base. Place the NucleoSpin® Plasmid Binding Plate (white rings) on top of the spacers. Insert NucleoSpin® Plasmid Filter Plate (violet rings) into the manifold lid and place the lid on the manifold base. Close the manifold base with the manifold lid. Close the vacuum manifold's valve.

5 Transfer crude lysates onto the NucleoSpin® Plasmid Filter Plate

Transfer the crude lysates resulting from step 4 carefully and completely into the wells of the NucleoSpin® Plasmid Filter Plate.

Note: Mix the suspension by pipetting up and down the entire volume once before transfer to the NucleoSpin® Plasmid Filter Plate.

6 Clear crude lysate by vacuum filtration

Apply vacuum of **-0.2 to -0.4 bar* (1–5 min)**. If necessary, press down the NucleoSpin® Plasmid Filter Plate slightly until flow through starts. Adjust vacuum to establish a flow rate of 1–2 drops per second.

When the crude lysate has passed the NucleoSpin® Plasmid Filter Plate, release the vacuum.

7 Reassemble vacuum manifold

Remove and discard the NucleoSpin® Plasmid Filter Plate. Open the manifold lid. Remove the NucleoSpin® Plasmid Binding Plate (white rings) with cleared lysates.

Insert the MN Wash Plate on the spacers inside the manifold base (see page 18). Close the manifold base with the manifold lid. Place the Binding Plate on top of the manifold.

8 Bind DNA to silica membrane

Apply vacuum of **-0.2 to -0.4 bar* (1 min)**. If necessary, press down the NucleoSpin® Plasmid Binding Plate slightly until flow through starts. Adjust vacuum to establish a flow rate of 1–2 drops per second.

When the cleared lysate has drained off, release the vacuum.

* Reduction of atmospheric pressure

9 Wash silica membrane

1st wash (optional)

Add **600 µL Buffer AW** to each well. Apply vacuum of **-0.2 to -0.4 bar* (1 min)**. If necessary, press down the NucleoSpin® Plasmid Binding Plate slightly. Allow the buffer to pass the wells.

Release the vacuum.

Note: This additional wash step is recommended if the bacterial host strain has a high endogenous nuclease activity (e.g., E. coli HB 101, BMH 71-18 mutS, JM, or any wild-type strains) or if sequencing results need to be improved.

2nd wash

Add **900 µL Buffer A4** (with ethanol) to each well. Apply vacuum of **-0.2 to -0.4 bar* (1 min)** and allow the buffer to pass the wells.

Release the vacuum.

3rd wash

Repeat the wash step with **900 µL Buffer A4**. Apply vacuum of **-0.2 to -0.4 bar*** (1 min) and allow the buffer to pass the wells.

Release the vacuum.

10 Remove MN Wash Plate

After the final washing step, close the valve, release the vacuum, and remove the NucleoSpin® Plasmid Binding Plate. Remove manifold lid, MN Wash Plate, and waste container from the vacuum manifold.

11 Dry NucleoSpin® Plasmid Binding Plate

Remove any residual wash buffer from the NucleoSpin® Plasmid Binding Plate. If necessary, tap the outlets of the plate onto a clean paper sheet (supplied with the MN Wash Plate) or soft tissue until no drops come out.

Close the manifold base with the manifold lid. Place the NucleoSpin® Binding Plate on top of the manifold.

Apply vacuum of **-0.4 to -0.6 bar*** for **at least 10–15 min** to dry the membrane completely. Run vacuum pump continuously. Typically, the adjusted vacuum is not reached at this step. Achieving and keeping a continuous air-flow in order to evaporate the remaining ethanol from Wash Buffer A4 is of more importance than reaching the precise mentioned atmospheric pressure.

Note: The ethanol in Buffer A4 inhibits enzymatic reactions and has to be completely removed before eluting the DNA.

Finally, release the vacuum.

* Reduction of atmospheric pressure

12 Insert Elution Plate U-bottom

Remove the manifold lid with the NucleoSpin® Plasmid Binding Plate from the vacuum manifold. Insert the Elution Plate on the spacers inside the manifold base. Close the manifold base with the manifold lid. Place the NucleoSpin® Plasmid Binding Plate (white rings) on top of the manifold (see page 18).

For elution into microtiter plates, spacers 'MTP/Multi-96 Plate' are required which are already inserted into the manifold base from the previous steps.

13 Elute plasmid DNA

Elute the DNA by adding 125 µL Buffer AE (5 mM Tris-HCl, pH 8.5; 125 µL is recommended, a volume range of 75–150 µL is possible, see section 2.7) or sterile distilled water (pH 7.5–8.5) to each well of the NucleoSpin® Plasmid Binding Plate.

The elution buffer should be dispensed carefully onto the center of the silica membrane. Incubate the buffer on the membrane for **1–3 minutes** at **room temperature**. Apply vacuum of **-0.4 to -0.6 bar* (1 min)**. If necessary, press down the NucleoSpin® Plasmid Binding Plate slightly and collect the eluted DNA. After the elution buffer has passed the wells, release vacuum.

Remove the Elution Plate U-bottom containing eluted DNA and seal the strips / plate with adhesive cover foil or Cap Strips, respectively, for further storage.

5.2 NucleoSpin® 96 Plasmid – elution of DNA using a centrifuge

Elution of purified DNA in a centrifuge can be performed be necessary when higher concentrations of the final DNA are required for downstream applications. Using a centrifuge allows the dispensed volume to be reduced down to 50–75 µL.

Required hardware:

- For centrifugation, a microtiterplate centrifuge that can accommodate the NucleoSpin® Plasmid Binding Plate stacked on a rack of Tube Strips is required (bucket height: 85 mm). It is also necessary that the centrifuge reaches accelerations of 5,600–6,000 x g.
- Suitable elution tubes: Rack of Tube Strips have to be ordered separately (see ordering information).

1 Stop the method after the final washing step with **Buffer A4**. Remove the NucleoSpin® Plasmid Binding Plate from the manifold's top and tap on a sheet of filter paper to remove residual wash buffer from the outlets.

2 Place the NucleoSpin® Plasmid Binding Plate on top of a MN Square-well Block (not included in the kits, see ordering information) and centrifuge for **10 min** at **maximum speed** (> 4,000 x g, optimal 5,800 x g).

Note: Do not use a microtiter plate as a support for the NucleoSpin® Plasmid Binding Plate. Microtiter plates may crack under centrifugation at > 1,500 x g.

3 Place the NucleoSpin® Plasmid Binding Plate on top of a Rack of Tube Strips. Dispense **Elution Buffer AE** (50–150 µL) directly onto the silica membrane and incubate for **1–3 min** at **room temperature**.

Note: Do not use a microtiter plate as elution plate. Microtiter plates may crack under centrifugation at > 1,500 x g. Alternatively, a 96-well PCR plate can be inserted into the Square-well Block for elution.

4 Centrifuge for **2 min** at **maximum speed** (> 4,000 x g, optimal 5,800 x g) to collect the plasmid DNA.

Remove the Rack of Tube Strips containing eluted DNA and close them with Cap Strips for further storage.

6 Appendix

6.1 Troubleshooting

Problem	Possible cause and suggestions
Incomplete lysis of bacterial cells	<i>Cell pellet not properly resuspended</i>
	<ul style="list-style-type: none"> It is essential that the cell pellet is completely resuspended prior to lysis. No cell clumps should be visible before addition of Lysis Buffer A2. If necessary, increase number of mixing cycles or duration of shaking.
	<i>SDS in Buffer A2 precipitated</i>
Poor plasmid yield	<ul style="list-style-type: none"> SDS in Buffer A2 may precipitate upon storage. If this happens, a white precipitate is visible at the bottom of the bottle. Incubate Buffer A2 at 30–40 °C for 5 min and mix well before use.
	<i>Too many bacterial cells used</i>
	<ul style="list-style-type: none"> Usage of LB as the growth medium is recommended. When using rich media like TB, cultures reach very high cell densities. Reduce culture volume to 1.0–1.5 mL.
	<i>No or not enough antibiotic used during cultivation</i>
	<ul style="list-style-type: none"> Cells harboring the plasmid of interest may become overgrown by non-transformed cells. Add appropriate amounts of freshly prepared stock solutions of antibiotic to all media.
	<i>Overgrown bacterial cultures</i>
Poor plasmid yield	<ul style="list-style-type: none"> See suggestions in section 2.6 'Growth of bacterial cultures'.
	<i>High-copy number plasmid was not used</i>
	<ul style="list-style-type: none"> Use high-copy number plasmid.
	<i>Incomplete lysis of bacterial cells</i>
	<ul style="list-style-type: none"> See 'Possible cause and suggestions' above.
	<i>No ethanol was added to Buffer A4 Concentrate, ethanol evaporated</i>
Poor plasmid yield	<ul style="list-style-type: none"> Add indicated volume of ethanol to Buffer A4 Concentrate and mix. Keep bottle tightly closed to prevent evaporation of ethanol.
	<i>Elution conditions are not optimal</i>
	<ul style="list-style-type: none"> If possible, use a slightly alkaline elution buffer like Buffer AE (5 mM Tris-HCl, pH 8.5). When using nuclease-free water for elution, make sure the pH value is within the range of pH 8.0–8.5. Elution efficiencies drop drastically at pH < 7.

Problem	Possible cause and suggestions
----------------	---------------------------------------

Contamina- tion with chromo- somal DNA	<i>Excessive mixing steps</i>
	<ul style="list-style-type: none">• Reduce number of mixing cycles, reduce shaker action after addition of Lysis Buffer A2 and Neutralization Buffer A3 or before transfer of crude lysate to the NucleoSpin® Plasmid Filter Strips. Mixing will cause shearing of chromosomal DNA, leading to a co-purification during the preparation of plasmid DNA.
	<i>Culture volume was too high</i>
	<ul style="list-style-type: none">• Reduce culture volume if lysate is too viscous for gentle and complete mixing.
	<i>Bacterial culture overgrown</i>
	<ul style="list-style-type: none">• Overgrown bacterial cultures contain lysed cells and degraded DNA. See suggestions in section 2.6 'Growth of bacterial cultures'.
	<i>Lysis was too long</i>
	<ul style="list-style-type: none">• Lysis step must not exceed 5 min.
	<i>Tips</i>
	<ul style="list-style-type: none">• Use wide bore disposable tips for transfer of crude lysate to the NucleoSpin® Plasmid Filter Plate to prevent shearing of chromosomal DNA.
RNA in the eluate	<i>RNA was not degraded completely</i>
	<ul style="list-style-type: none">• Ensure that RNase A was added to Buffer A1 before use.• Reduce culture volume if necessary.

Problem **Possible cause and suggestions**

Suboptimal performance of plasmid DNA in sequencing reactions, problems with downstream applications	<p><i>Carry-over of ethanol, inhibition of downstream analysis, or problems with sample loading onto agarose</i></p> <ul style="list-style-type: none"> • Be sure to remove all of ethanolic Buffer A4 after the final washing step. Dry the NucleoSpin® Plasmid Binding Plate for at least 10 min with maximum vacuum. <p><i>Elution of plasmid DNA with TE buffer</i></p> <ul style="list-style-type: none"> • EDTA may inhibit enzymatic reactions like DNA sequencing. Repurify the plasmid DNA and elute with Buffer AE or nuclease-free water. Alternatively, the plasmid DNA may be precipitated with ethanol, and redissolved in Buffer AE or nuclease-free water. <p><i>E.coli strains with high endogenous-nuclease levels are used as host</i></p> <ul style="list-style-type: none"> • Perform the washing step with Buffer AW before washing with ethanolic Buffer A4. <p><i>Not enough DNA used for sequencing reactions</i></p> <ul style="list-style-type: none"> • Quantitate DNA by agarose gel electrophoresis before setting up sequencing reactions.
--	---

6.2 Ordering information

Product	REF	Pack of
NucleoSpin® 96 Plasmid	740625.1	1 x 96 preps
	740625.4	4 x 96 preps
	740625.24	24 x 96 preps
NucleoSpin® 96 Plasmid Core Kit	740616.4	4 x 96 preps
	740616.24	24 x 96 preps
NucleoSpin® 8 Plasmid	740621	12 x 8 preps
	740621.5	60 x 8 preps
NucleoSpin® 8 Plasmid Core Kit	740461.4	48 x 8 preps
Buffer A1 (without RNase A)	740911.1	1 L
Buffer A2	740912.1	1 L
Buffer A3	740913.1	1 L
Buffer A4 Concentrate (for 1 L Buffer A4)	740914	200 mL
Buffer AW	740916.1	1 L

Product	REF	Pack of
Buffer AE	740917.1	1 L
RNase A (lyophilized)	740505	100 mg
NucleoVac 96 Vacuum Manifold	740681	1
NucleoVac Vacuum Regulator	740641	1
Round-well Block with Cap Strips	740475 740475.24	4 sets 24 sets
Rack of Tube Strips (1 set consists of 1 rack, 12 strips with 8 tubes each, and 12 Cap Strips)	740477 740477.24	4 sets 24 sets
Cap Strips	740478 740478.24	48 288
MN Square-well Block	740476 740476.24	4 24
MN Wash Plate	740479 740479.24	4 24
Culture Plate (with Gas-permeable Foil)	740488 740488.24	4 sets 24 sets
Elution Plate U-bottom (with Self-adhering Foil)	740486.24	24 sets
Gas-permeable Foil	740675	50
Self-adhering Foil	740676	50

Visit www.mn-net.com for more detailed product information.

6.3 Product use restriction / warranty

NucleoSpin® 96 Plasmid (Core Kit) components are intended, developed, designed, and sold FOR RESEARCH PURPOSES ONLY, except, however, any other function of the product being expressly described in original MACHEREY-NAGEL product leaflets.

MACHEREY-NAGEL products are intended for GENERAL LABORATORY USE ONLY! MACHEREY-NAGEL products are suited for QUALIFIED PERSONNEL ONLY! MACHEREY-NAGEL products shall in any event only be used wearing adequate PROTECTIVE CLOTHING. For detailed information please refer to the respective Material Safety Data Sheet of the product! MACHEREY-NAGEL products shall exclusively be used in an ADEQUATE TEST ENVIRONMENT. MACHEREY-NAGEL does not assume any responsibility for damages due to improper application of our products in other fields of application. Application on the human body is STRICTLY

FORBIDDEN. The respective user is liable for any and all damages resulting from such application.

DNA/RNA/PROTEIN purification products of MACHEREY-NAGEL are suitable for IN-VITRO-USES ONLY!

ONLY MACHEREY-NAGEL products specially labeled as IVD are also suitable for IN-VITRO-diagnostic use. Please pay attention to the package of the product. IN-VITRO-diagnostic products are expressly marked as IVD on the packaging.

IF THERE IS NO IVD SIGN, THE PRODUCT SHALL NOT BE SUITABLE FOR IN-VITRO-DIAGNOSTIC USE!

ALL OTHER PRODUCTS NOT LABELED AS IVD ARE NOT SUITED FOR ANY CLINICAL USE (INCLUDING, BUT NOT LIMITED TO DIAGNOSTIC, THERAPEUTIC AND/OR PROGNOSTIC USE).

No claim or representations is intended for its use to identify any specific organism or for clinical use (included, but not limited to diagnostic, prognostic, therapeutic, or blood banking). It is rather in the responsibility of the user or - in any case of resale of the products - in the responsibility of the reseller to inspect and assure the use of the DNA/RNA/protein purification products of MACHEREY-NAGEL for a well-defined and specific application.

MACHEREY-NAGEL shall only be responsible for the product specifications and the performance range of MN products according to the specifications of in-house quality control, product documentation and marketing material.

This MACHEREY-NAGEL product is shipped with documentation stating specifications and other technical information. MACHEREY-NAGEL warrants to meet the stated specifications. MACHEREY-NAGEL's sole obligation and the customer's sole remedy is limited to replacement of products free of charge in the event products fail to perform as warranted. Supplementary reference is made to the general business terms and conditions of MACHEREY-NAGEL, which are printed on the price list. Please contact us if you wish to get an extra copy.

There is no warranty for and MACHEREY-NAGEL is not liable for damages or defects arising in shipping and handling (transport insurance for customers excluded), or out of accident or improper or abnormal use of this product; defects in products or components not manufactured by MACHEREY-NAGEL, or damages resulting from such non-MACHEREY-NAGEL components or products.

MACHEREY-NAGEL makes no other warranty of any kind whatsoever, and SPECIFICALLY DISCLAIMS AND EXCLUDES ALL OTHER WARRANTIES OF ANY KIND OR NATURE WHATSOEVER, DIRECTLY OR INDIRECTLY, EXPRESS OR IMPLIED, INCLUDING, WITHOUT LIMITATION, AS TO THE SUITABILITY, REPRODUCTIVITY, DURABILITY, FITNESS FOR A PARTICULAR PURPOSE OR USE, MERCHANTABILITY, CONDITION, OR ANY OTHER MATTER WITH RESPECT TO MACHEREY-NAGEL PRODUCTS.

In no event shall MACHEREY-NAGEL be liable for claims for any other damages, whether direct, indirect, incidental, compensatory, foreseeable, consequential, or special (including but not limited to loss of use, revenue or profit), whether based upon

warranty, contract, tort (including negligence) or strict liability arising in connection with the sale or the failure of MACHEREY-NAGEL products to perform in accordance with the stated specifications. This warranty is exclusive and MACHEREY-NAGEL makes no other warranty expressed or implied.

The warranty provided herein and the data, specifications and descriptions of this MACHEREY-NAGEL product appearing in MACHEREY-NAGEL published catalogues and product literature are MACHEREY-NAGEL's sole representations concerning the product and warranty. No other statements or representations, written or oral, by MACHEREY-NAGEL's employees, agent or representatives, except written statements signed by a duly authorized officer of MACHEREY-NAGEL are authorized; they should not be relied upon by the customer and are not a part of the contract of sale or of this warranty.

Product claims are subject to change. Therefore please contact our Technical Service Team for the most up-to-date information on MACHEREY-NAGEL products. You may also contact your local distributor for general scientific information. Applications mentioned in MACHEREY-NAGEL literature are provided for informational purposes only. MACHEREY-NAGEL does not warrant that all applications have been tested in MACHEREY-NAGEL laboratories using MACHEREY-NAGEL products. MACHEREY-NAGEL does not warrant the correctness of any of those applications.

Last updated: 07/2010, Rev. 03

Please contact:
MACHEREY-NAGEL GmbH & Co. KG
Tel.: +49 (0) 24 21 969 270
e-mail: tech-bio@mn-net.com

Trademarks / Disclaimer:

NucleoSpin® is a registered trademark of MACHEREY-NAGEL GmbH & Co. KG

All used names and denotations can be brands, trademarks, or registered labels of their respective owner – also if they are not special denotation. To mention products and brands is only a kind of information (i.e., it does not offend against trademarks and brands and can not be seen as a kind of recommendation or assessment). Regarding these products or services we can not grant any guarantees regarding selection, efficiency, or operation.

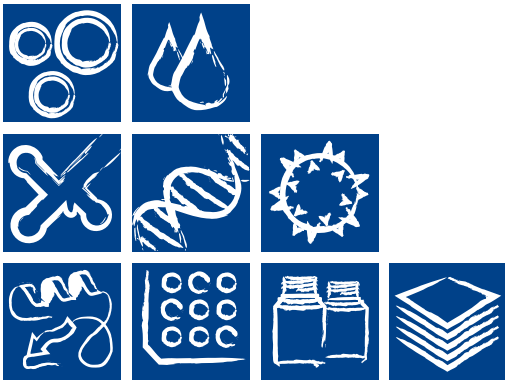

www.mn-net.com

MACHEREY-NAGEL



MACHEREY-NAGEL GmbH & Co. KG · Neumann-Neander-Str. 6-8 · 52355 Düren · Germany

DE / International:

Tel.: +49 24 21 969-0
 Fax: +49 24 21 969-199
 E-mail: info@mn-net.com

CH:

Tel.: +41 62 388 55 00
 Fax: +41 62 388 55 05
 E-mail: sales-ch@mn-net.com

FR:

Tel.: +33 388 68 22 68
 Fax: +33 388 51 76 88
 E-mail: sales-fr@mn-net.com

US:

Tel.: +1 484 821 0984
 Fax: +1 484 821 1272
 E-mail: sales-us@mn-net.com