



CASY

CELL COUNTER & ANALYZER | *Operators Guide* Version 2018-08

For life science research only. Not for use in diagnostic procedures.

OLS[®]
OMNI Life Science

Table of Contents

TABLE OF CONTENTS.....	2
PROLOGUE	5
I. Revision History	5
II. Contact Address	5
III. Declaration of Conformity.....	6
EC-Declaration of Conformity	6
IV. Warranty	7
V. Trademarks.....	7
VI. Intended Use	7
VIII. Warnings and Precautions	8
Handling Requirements	8
General Precautions	9
Electrical Safety.....	9
IX. Disposal of the Instrument.....	9
1. BASIC EQUIPMENT	10
2. INTRODUCTION	11
2.1 Functionality	11
2.2 Measuring Principle	11
2.2.1 Digital Pulse Processing	12
2.2.2 Pulse Area Analysis.....	13
2.2.3 Measuring Range Dynamics	13
2.3 Viability Determination Using Electrical Current Exclusion	15
2.4 Aggregation Correction	16
3. DEVICE CONFIGURATION.....	17
3.1 Measuring Unit	17
3.2 Measuring Capillary and External Electrode	19
3.3 Pressure System and Power Supply.....	20
3.4 Control Device.....	20

4. STARTUP	21
4.1 Choosing the Location	21
4.2 Assembly and Cabling	22
4.2.1 Installing the USB/RS232 Adapter	22
4.3 Software Installation	23
4.3.1 Software installation	23
4.3.2 Special installation steps for Control devices with touch screen	24
5. MAINTENANCE AND CARE	25
5.1 Weekly Cleaning Wizard	26
5.2 Clean Capillary Wizard	26
5.3 Deep Clean Wizard	26
5.4 Cleaning the Cylinders and the Sampling Chamber	26
5.5 How to Set the CASY System Out of Operation	26
6. OPERATION OF CASY	28
6.1 Switch ON / OFF and Login	28
6.2 Dashboard and Software Functions	29
6.2.1 System Settings	30
6.2.2 User Management.....	31
6.2.3 Emergency Password.....	31
6.3 Service	32
6.3.1 Service Menu – Dry Liquid System	32
6.3.2 Start Self-Test	33
6.3.3 Generate Test Pattern	33
6.3.4 Enter Service PIN	33
6.3.5 Weekly Cleaning Wizard.....	33
6.3.6 Clean Capillary Wizard.....	33
6.3.7 Deep Clean Wizard	33
7. PERFORMING AND EVALUATING MEASUREMENTS	34
7.1 Background monitoring	34
7.2 Preparing Samples	35
7.3 Measuring Samples and Displaying the Size Distribution	36
7.3.1 Measurements	36
7.3.2 Options for Measurement results	37
7.3.3 Templates.....	38
7.3.4 Cursor Settings	40
7.3.5 Aggregation correction.....	41

7.4 Points to be Observed When Performing Measurements	42
7.4.1 Changing the Samples	42
7.4.2 Sample Concentration	42
7.4.3 Measuring Pore Blockages	43
7.4.4 Air Bubbles	43
7.4.5 Empty Storage Container	44
7.4.6 Measuring Time Too Short	44
7.4.7 Interrupting the Measurement	44
7.5 Measurement results	45
7.5.1 Opening Measurement results.....	45
7.5.2 Overlay & Mean View.....	45
7.5.3 Table view.....	46
7.5.4 Importing Measurement results	46
7.5.5 Exporting Measurement results	46
8. TROUBLESHOOTING	47
9. APPENDIX	48
9.1 The Liquid/Pressure System	48
9.2 Technical Data on CASY	49

Prologue

I. Revision History

Version	Revision Date
2018-08	August 2018

© Copyright 2018, OLS OMNI Life Science GmbH & Co KG. All rights reserved.

Information in this document is subject to change without notice. No part of this document may be reproduced or transmitted in any form or by any means, electronic or mechanical, for any purpose, without the express written permission of OLS OMNI Life Science.

Questions or comments regarding the contents of this manual can be directed to the address below.

OLS OMNI Life Science GmbH & Co. KG
Karl-Ferdinand-Braun-Str. 2
28359 Bremen
Phone: 0421 | 27 61 69-0
email: info@ols-bio.de

Online Support

CASY online support is available on www.cellcounting.de.

- + direct online contact
- + manuals, literature & template files
- + video manuals
- + tips & tricks
- + trouble-shooting

Every effort has been made to ensure that all the information contained in the CASY Operator's Guide is correct at the time of printing.

However, OLS OMNI Life Science GmbH & Co KG reserves the right to make any changes necessary without notice as part of ongoing product development.

II. Contact Address

Manufacturer



OLS OMNI Life Science GmbH & Co. KG
Karl-Ferdinand-Braun-Str. 2
28359 Bremen
Phone: +49-421 | 27 61 69-0
Email: info@ols-bio.de
www.cellcounting.de/www.ols-bio.de

III. Declaration of Conformity

EC-Declaration of Conformity

Translation

Manufacturer: OMNI Life Science GmbH & Co. KG
Karl-Ferdinand Braun Straße 2
28359 Bremen
Germany

OMNI Life Science GmbH & Co. KG declares that the product

Product name: CASY TTT
ID No.: 5651736, 5651737, 5651738

to which this relates, meets the protection requirements laid down in:

Council Directive 2014/30/EU on the alignment of the legal provisions of the Member States on the electromagnetic compatibility (EMC).

and

Council Directive 2014/35/EU on the alignment of the legal provisions of the Member States on the electromagnetic equipment for use within certain voltage limits.

To assess the product with regard to these Council Directives, the following relevant harmonized European Standards were applied:

EMC: IEC 61326-1:2012; DIN EN61326-1:2013-07
-Emission: Class B CISPR11:2015; EN55011:2016; EN55011:2017-03
-Immunity test requirements for equipment used in controlled EM Environments
(DIN EN 61326-1:2013-07, Table 3)
Safety: IEC61010-1:2010; DIN EN61010-1:2011-07 (VDE 0411-1:2011-07)

Bremen, July 19th, 2018

OMNI Life Science GmbH & Co. KG

CE Plenipotentiary

Contact Address: OMNI Life Science GmbH & Co. KG
Karl-Ferdinand Braun Straße 2
28359 Bremen
Germany

IV. Warranty

The warranty conditions are specified in the sales contract. Contact your OLS representative for further information. Any unauthorized modification of the instrument invalidates guarantee and service contract.

V. Trademarks

CASY is a trademark of OMNI Life Science GmbH & Co KG. Other brands or product names are trademarks of their respective holders.





VI. Intended Use

The CASY is intended for highly standardized cell counting and accurate measurement of cell viability, cell aggregation, and cell volume. The technology of the CASY combines a proven particle measurement technique, referred to as the electrical sensing zone technique (ISO 13319), with a modern method of signal evaluation, pulse area analysis. The CASY is intended for **life science research** and must be used exclusively by laboratory professionals who are trained in laboratory techniques and have studied the instructions for use of this instrument. **The CASY is not intended for use in diagnostic procedures.**

VII. Conventions Used in this Operator's Guide

Symbols

In this Operator's Guide, symbols are used as a visual signal to highlight important points.

Symbol	Heading	Description
	WARNING	This symbol is used to indicate that noncompliance with instructions or procedures could lead to physical injury or even death, or could cause damage to the instrument.
	BIOHAZARD	This symbol indicates that certain precautions must be taken when working with potentially infectious sample material.
	IMPORTANT NOTE	Information critical to the success of the procedure or use of the product.
	INFORMATION NOTE	Additional information about the current topic or procedure.

The following symbols appear on the instrument:

Symbol	Heading	Description
	WEEE	Electrical and electronic equipment marked with this symbol are covered by the European Directive WEEE. The symbol denotes that the equipment must not be disposed off in the municipal waste system.

VIII. Warnings and Precautions

Handling Requirements

It is important to observe the following safety instructions and guidelines in order to ensure safe and reliable operation of the CASY:

- + Place the instrument on a solid, dry work table that is exposed to neither strong mechanical vibrations nor high-volume noises (e.g., ultrasonic baths).
- + Choose the installation site so that the CASY is protected from mechanical damage and water or solvent spillage.
- + Choose a room that is as smoke- and dust-free as possible and that has a constant room temperature of +15 to +32°C.
- + Do not place the CASY in the vicinity of devices that generate strong electrostatic or electromagnetic fields. This specifically includes computer monitors that work with high-voltage picture tubes, brush motors, flickering fluorescent lamps, arcing contacts, water baths, and gas chromatographs. If no alternative site is available, maintain the greatest possible distance from such devices.
- + Only trained personnel in a controlled laboratory environment should operate the CASY.
- + All services and repairs should be performed by authorized service technicians only.
- + Always ensure that there is sufficient CASYton in the CASYton storage container.
- + Clean the containers before reusing them.
- + Always observe the safety regulations when handling CASYton and CASYclean.
- + Waste contaminated with tissue or cells, for example, waste containers, CASYcups, pipette tips, etc., must be disposed according to the recommended rules for handling biohazardous materials.
- + Any leaks in the liquid management system must be repaired immediately. Contact your distributor or authorized service technician.
- + When the CASY fluid system contains CASYton, always ensure that it does not dry out, to prevent malfunction or damage to the fluid system and valves caused by salt crystals.
- + Always wear protective clothing, particularly gloves, when handling samples with any risk of biohazard.
- + Dirt or dust particles should not gain access into the device.
- + Ensure that all equipment required for sample preparation, for example, CASYcups, pipette tips, etc., are stored in a dust-free environment and are free of any grease or oil. Even minor amounts of grease or oil may cause high background readings, especially with the 60 µm and the 45 µm capillary.



For your own safety, please consider all biological material as potentially infectious. Handling and disposal of such material should be performed according to local safety guidelines. Spills should be immediately disinfected with an appropriate disinfectant solution to avoid spreading infection to, and contamination of, laboratory personnel or equipment. When working with potentially infectious material, always use protective gloves (powder-free).

- + Please see chapter 5. *Maintenance and Care* for instructions on cleaning the CASY.

General Precautions



Make sure that the main switch can be reached easily. Inappropriate location of the instrument can cause incorrect results and damage to the equipment parts.



Keep all potential flammable or explosive material (e.g., anesthetic gas) away from instrument. Spraying liquid on electrical parts can cause a short circuit and result in fire.



During firefighting operations, disconnect the power line of the CASY

Electrical Safety



The CASY is designed in accordance with Protection Class I (IEC). The chassis/ housing of the instrument is grounded to protection earth (PE) by means of a cord. For protection against electrical shock hazards, the instrument must be directly connected to an approved power source such as a three-wire grounded receptacle for the 110 V or 230 V line. **Do not use an ungrounded receptacle**; have a qualified electrician replace the ungrounded receptacle with a properly (PE) grounded receptacle in accordance with the local electrical code. Do not use an extension. Any break in the electrical ground path, whether inside or outside the instrument, could be hazardous.

Under no circumstances should the user attempt to modify or deliberately defeat the safety features of this instrument. If the power cord becomes cracked, frayed, broken, or otherwise damaged, replace it immediately with the equivalent part from OLS OMNI Life Science.

IX. Disposal of the Instrument

All electrical and electronic products should be disposed of separately from the municipal waste system. Proper disposal of your old appliance prevents potential negative consequences for the environment and human health.



The instrument must be treated as biologically contaminated hazardous waste. Final disposal must not endanger waste handlers. As a rule, such equipment must be sterile before it is passed on for final disposal. For more information contact your local OLS support personnel. The instrument should also be decontaminated prior to shipping it for outside service or repairs.



Components of your CASY which are marked with the crossed-out wheeled bin symbol are covered by the European Directive 2002/96/EC (WEEE).

These items must be disposed of via designated collection facilities appointed by government or local authorities. For more information about disposal of your old product, please contact your city office, waste disposal service or your local OLS support personnel.



It is left to the discretion of the responsible laboratory organization to determine whether the CASY Instrument or the control unit are contaminated.

1. BASIC EQUIPMENT

The basic equipment of CASY includes the following components:

- + Measuring unit with sample platform, waste container, CASYton storage container and control unit (computer is not automatically included and has to be ordered separately)
- + One to three precision measuring capillaries (depending on version)
- + External electrode
- + Protection shield including cable
- + Adapter and USB cable for communication between control and measuring unit
- + Main power supply cable to the measuring unit
- + Binder containing documents (including Operator's Guide) for CASY
- + Calibration certificate and standardized test-pattern for each capillary
- + CASY Installation USB Stick (incl. CASY Emergency Password Program)



*The **CASY Emergency Password** program enables a **Supervisor Password** to be generated. Ensure that only authorized personnel have access to these passwords (see section 6.2.3).*

2. INTRODUCTION

The technology of the CASY System is based on extensive experience gained in analytical working methods in the fields of cytobiology, microbiology, biochemistry, and physics. Its ergonomic and easy operation were developed specifically for day-to-day, routine use. Standardized cell counting methods and accurate measurement of cell viability, cell aggregation, and cell volume with high measuring range dynamics make the CASY Cell Counter and Analyzer an indispensable tool for the qualitative and quantitative assessment of cell cultures and many other sample types.

2.1 Functionality

The features of the CASY instrument are cell counting and cell analyzing. The analyzing function additionally determines parameters which are important for the quality control of cell cultures and other cell types. These include:

+ High-resolution size distribution

The size distribution of a cell culture is a typical characteristic and serves as a fingerprint of the status of the cells.

+ Cell volume

The cell volume is precisely measured by the CASY instrument. Based on the cell volume, the corresponding cell diameter is calculated.

+ Aggregation correction

Determination of the mean degree of cell aggregation. The aggregation factor is used to calculate the total number of single cells, including cells in cell clusters (aggregation correction).

+ Viability determination

Viability of mammalian cells, when analyzed in monoculture, is measured by a non-invasive method, the electrical current exclusion. However, there can be situations in which viability determination using electrical current exclusion is not possible (see section [2.3 Viability Determination Using Electrical Current Exclusion](#)).

+ Debris

Small debris particles originating from cell destruction or extracellular matrix (cell debris) can be recognized and quantified aside from the cell populations by the CASY Cell Counter and Analyzer. The contamination by cell debris can be used as an additional parameter for the quality control of the cell culture.

The calibration of the CAS instrument is factory certified and non-changeable by the user, offering a very high level of standardization. This guarantees that the results can be compared from user to user, lab to lab, day to day, and instrument to instrument.

2.2 Measuring Principle

The technology of CASY combines a proven particle measurement technique, referred to as the “Electrical Sensing Zone” technique (ISO 13319), with a modern method of signal evaluation, the “Pulse Area Analysis”.

2.2.1 Digital Pulse Processing

Pulse Area Analysis was developed in 1987 on the basis of Digital Pulse Processing (DPP), a technique developed for the digital recording of electrical signals more than 40 years ago. For cell analysis, DPP is combined with a high scanning rate and a highly standardized method of analyzing cell signals. This combination facilitates unprecedented measuring range dynamics and guarantees maximum resolution and excellent reproducibility for all measuring parameters.

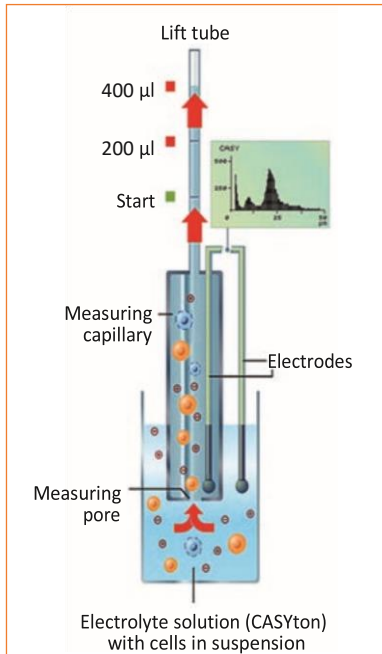

Figure 1: Measurement principle of the CASY Cell.

As shown in *Figure 1*, cells are suspended in CASYton, an electrolyte developed specifically for cell counting. For the measurement, the cells are aspirated through a precision measuring pore of defined geometry at a constant flow speed.

Signal Generation

The precision measuring pore is a hole, which is cast inside the capillary body. The electrolyte-filled measuring pore represents a defined electrical resistance (constant current). During their passage through the measuring pore, the cells displace electrolyte and thereby generate electrical pulses. Each generated electrical pulse is recorded as a cell count, and the size of each pulse is equivalent to the cell volume because every cell displaces exactly the quantity of electrolyte corresponding to its cell volume. The changes in voltage when a cell or particle is passing the pore are sampled with a frequency of 1 MHz.

Measuring Volume

For calculation of the cell concentration, it is essential to know the exact volume of the cell suspension passing the measuring pore. This volume (measuring volume) can be defined by the user and is precisely determined by the CASY System using a lift tube, which is calibrated in volume.

2.2.2 Pulse Area Analysis

The measuring signal (for example, the electrical pulse generated by a cell when passing the measuring pore) is scanned by CASY at high frequency (1 MHz). As well as the amplitude of the measuring signal, it also records the shape and time course of the signal as a whole (see Figure 2).

The CASY calculates the integral of the measuring signal from the individual readings. The calculated signal areas are evaluated by a standardized method and accumulated in a multi-channel analyzer. From the original volume-linear size distribution with a resolution of 512.000 measuring channels, a diameter-linear size distribution with a resolution of 1024 display channels is finally calculated.

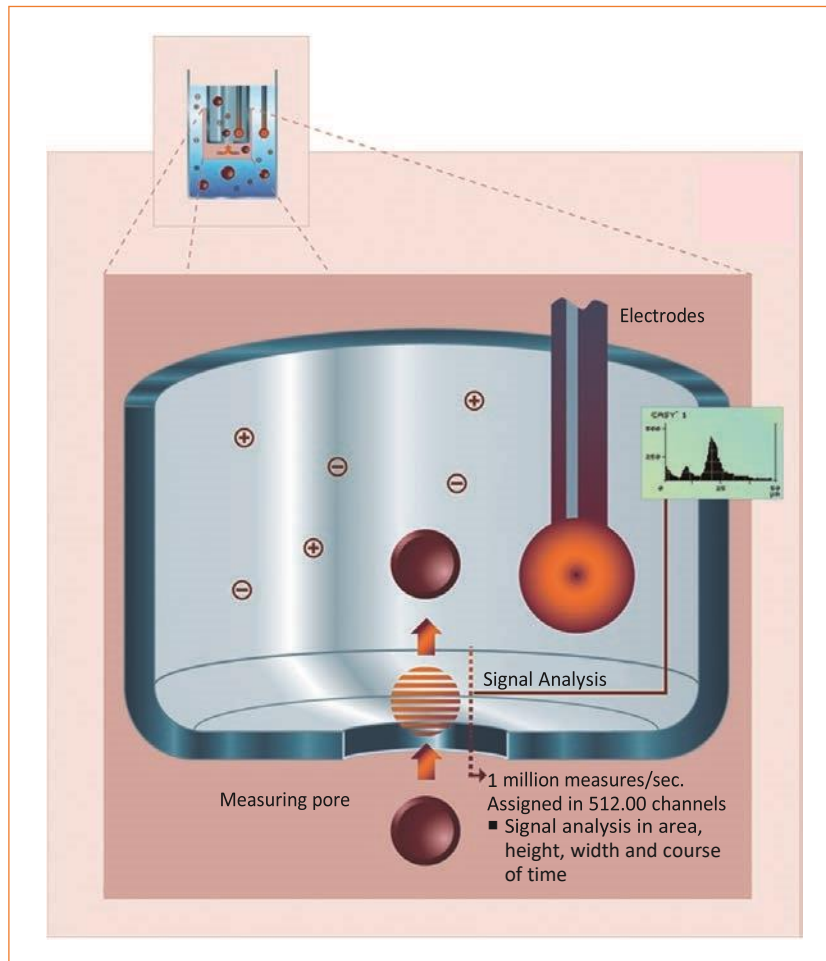

3, 2: Pulse Area Analysis

2.2.3 Measuring Range Dynamics

The signal amplifier technology, developed specifically for the CASY instrument, guarantees excellent measuring range dynamics (>1:70,000 in terms of volume and >1:40 in terms of diameter, respectively).

Measuring range dynamics is described as the ratio of the smallest to the largest particle that can be analyzed simultaneously. This guarantees that the entire physical measuring range of the measuring capillaries used, from approximately 2% to approximately 80% of the measuring pore diameter, is always in view.

As an example, the entire physical measuring range of the 150 μm capillary ranges from 3.2 μm (2% of 150 μm) to 120 μm (80% of 150 μm) which relates to a dynamic range of 1:40. Therefore very small objects and very big objects can be analyzed in the same measurement.

By analyzing cell cultures, this means that you can analyze everything from very small debris particles up to very large cell aggregates simultaneously. Figure 3 shows a typical size distribution of an animal cell line generated by the CASY Cell Counter and Analyzer. Based on the precisely determined cell volumes, the CASY Cell Counter and Analyzer calculates the corresponding cell diameters, which are displayed together with their associated absolute counts, resulting in a high-resolution size distribution.

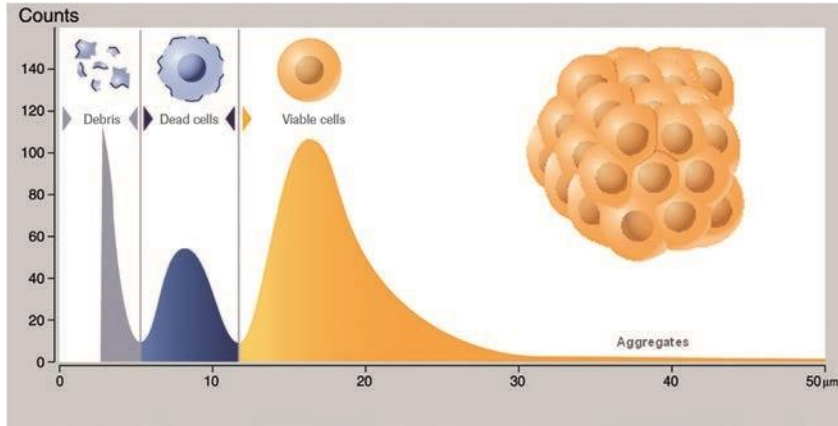

Figure 3: Typical CASY Cell Counter and Analyzer size distribution using an animal cell line.

Capillary Sizes

In order to cover different size ranges for specific applications, capillaries with different pore sizes are available covering different measuring ranges. In addition to the 150 μm capillary, the 45 μm capillary (pore size 45 μm) and the 60 μm capillary (pore size 60 μm) are offered.

A CASY can be delivered with combinations of the three capillaries (150 μm , 60 μm , and 45 μm). The 45 μm capillary detects objects starting from 0.7 μm and therefore used, for example, to analyze bacteria or small fungi, whereas the 60 μm capillary detects objects starting from 1.2 μm and is used, for example, to analyze yeast cells, platelets, sperms or algae.

Based on the measurement principle and different available capillary sizes, a broad range of objects can be analyzed by the CASY, for example, all types of mammalian cells (cell lines and primary cultures), blood cells, algae cells, yeast cells, bacteria, sperm, pollen, worm eggs, and particles.

2.3 Viability Determination Using Electrical Current Exclusion

The CASY Systems uses a label-free, non-invasive method, called Electrical Current Exclusion, for measuring cell viability of mammalian cell lines. Viability determination may also be possible with other eukaryotic cells, for example algae.

As with well-known dye-based assays, this viability determination depends on the membrane integrity of the cells. Intact cells have intact cell membranes. They can generally be considered as electrical isolators and an increased level of resistance is achieved over the measuring pore. This increase in resistance is a dimension for the volume of cells. In contrast, dead cells which membranes no longer act as an electrical barrier are recorded mainly by the size of their cell nucleus (see Figure 4). In order to guarantee the ability for viability determination, it is important that the cells pass through the pore individually.

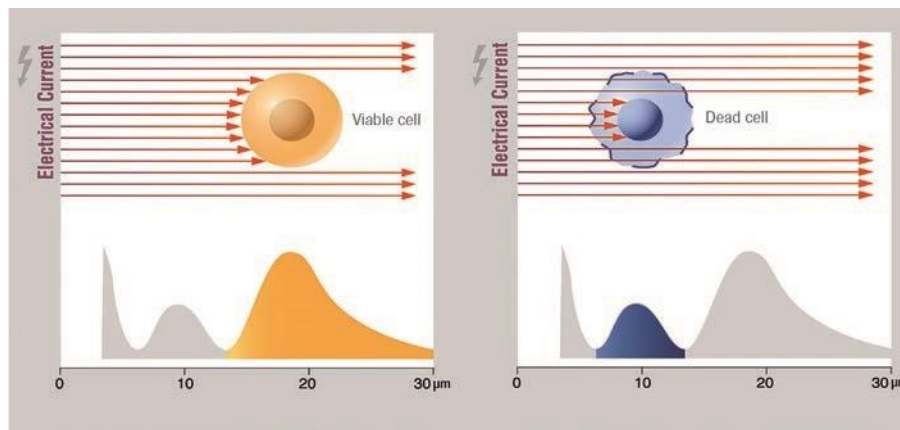

Figure 4: Viability determination of an animal cell line using the electrical current exclusion method.

Dead and Viable Cursors (Viability Mode)

As the volume of the cell nucleus is significantly smaller than the volume of the entire cell, the populations “debris,” “dead cells,” and “viable cells” can be clearly distinguished within the high-resolution size distribution. For calculating the viability in the analyzed suspension, two pairs of cursors are available to define specific size ranges and to calculate the percentage of viable cells.

- + The counts in the size range of the “dead cells” cursors define the number of dead cells.
- + The counts in the “viable cells” cursor range define the number of viable cells.

Therefore, viability in % is calculated by the number of viable cells divided by the total number of cells (Sum of dead and viable cells)



If objects with the same volume as dead cells are also present in the suspension to be analyzed, they are recorded in the size range of dead cells as well, and therefore viability determination is not possible. The reason is that these objects would further increase the number of total cells counted, which would incorrectly lower the viability.

For more information on using the dead cells and viable Cell cursors, see section [7.3.4 Cursor Settings](#).

2.4 Aggregation Correction

The CASY instrument offers a method to analyze even clumpy cell suspensions with its integrated aggregation correction. By analyzing the size distribution, CASY determines the most common cell size and the volume of the statistically “representative single cell” (see Figure 5). The typical single cell volume is displayed in the analysis protocol as the peak volume. The total volume of all measured events in the size range of single cells plus aggregates is divided by the volume of the representative single cell (peak volume) to calculate the total number of single cells.

Cell aggregates thereby are classified into their single cells, thus making it possible to determine the single cell count, including the number of single cells in aggregates. CASY represents this correction in form of an aggregation factor. The mean aggregation factor is used to record the aggregation correction. This parameter also can be used as a further quality control parameter for the characterization of cell cultures.

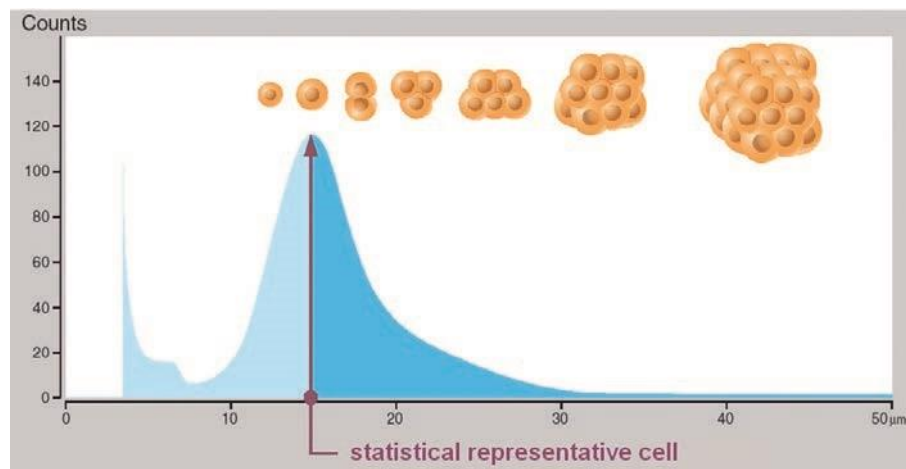

Figure 5: Detection of aggregates using the CASY System.

For more information on using aggregation correction and determining the aggregation factor, see section [7.3.5 Aggregation Correction](#).

3. DEVICE CONFIGURATION

The CASY combines a high degree of ergonomics with functionality. The measuring unit is controlled and the measuring data is evaluated and displayed by a computer (not included in CASY part number). This guarantees simple and easy-to-learn operation and a high degree of operating reliability. Measuring and evaluation parameters can be stored in application-specific templates that can be retrieved with one click, allowing users to focus completely on their work.

Access is controlled by integrated user management with password protection and defined security levels. Data are stored in a database file which can be backed up. A corresponding pass way can be defined in [6.2.1 System Settings](#).

The CASY comprises the following functional units:

- + Measuring unit consisting of measuring unit, pressure system, and mains power supply.
- + Precision measuring capillaries (see Figure 6). Depending on the configuration one of the capillaries is installed on delivery. Additional capillaries (optional) are delivered in their storage cups included in the accessory box.
- + Control Device consisting of Windows 10 based notebook or touchpad. The Control device must be ordered separately.

Measuring unit, pressure system, and mains power supply are accommodated in three separate metal cylinders. This guarantees maximum protection for the highly sensitive measuring electronics. The additional use of a protection shield, positioned around the capillary during the measurements, completely avoids external interference.

Consumables such as CASYton, CASYclean, CASY cup, and CASY blue, as well as accessories like CASY rack and dispenser, must be ordered separately.

3.1 Measuring Unit

The measuring unit (see Figure 6) contains the measuring electronics, the fluid system, and the valves required to control the measuring process. A schematic diagram of the fluid/pressure system including all valves can be found in [9.1 The Liquid/Pressure System](#). The close monitoring of the measuring volume (200 µl or 400 µl) required to determine the concentration is carried out by a light-barrier monitored, calibrated precision vertical tube. The CASY System handles larger measuring volumes (maximum 3.6 ml) by employing a multiple measurement cycles. The results of the individual measurement cycles are accumulated.

Control and monitoring of the measuring process are designed to provide maximum protection against interference. Any faults that do occur are automatically detected by the CASY System. Depending on the setting, the system automatically attempts to remedy the fault or the user receives an immediate corresponding error message.

The sampling chamber accommodates the following elements (see Figure 6):

- + Measuring capillary
- + External electrode
- + Sampling platform
- + Protection shield (positioned during measurements)
- + Waste container (left)
- + Storage container (right)

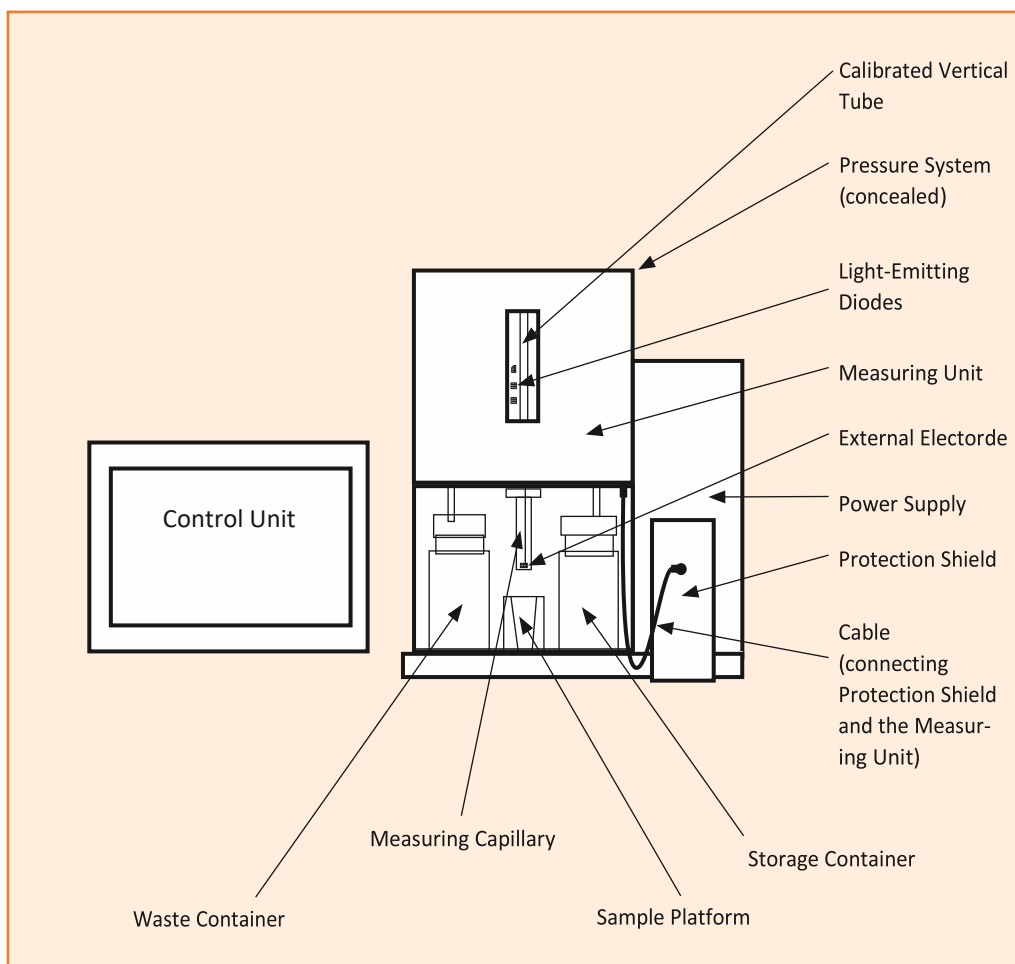

Figure 6: Schematic of CASY, measuring unit, frontal view.

An inspection window, which also enables the vertical tube to be monitored visually, is situated above the sampling chamber. In the inspection window you can see three light-emitting diodes, which indicate the filling level of the vertical tube. The green light-emitting diode indicates the start of a measurement, the lower red light-emitting diode indicates when the 200 μl level is reached, and the upper red light-emitting diode indicates when the 400 μl level is reached.

Before the start of each measurement, the contents of the measuring capillary are emptied into the waste container. The sample volume is then aspirated through the measuring capillary under constant low pressure. The progress can be tracked in the inspection window. The time required to reach the light barriers depends on the diameter of the measuring capillary and is precisely monitored by the CASY. This process enables potential faults resulting from a measuring capillary blockage or narrowing to be automatically detected. During the measurement process, the vertical tube is also monitored for disturbances caused by air bubbles.

Blockages can be removed by running a purge cycle, which, in addition to refilling the internal fluid system, also actively counter-flushes the capillary pore (see [7.4.3 Measuring Pore Blockages](#)). The required amount of CASY ton is sucked in from the storage container and then emptied into the waste container. The entire volume of the internal fluid system is approximately 2 ml.

3.2 Measuring Capillary and External Electrode

The **external electrode** (see Figure 6) is made of platinum, arranged in front of the capillary, can rotate freely, and be pulled downwards if necessary.

The **measuring capillary** (see Figure 6) is made of highly resistant plastic. It is secured to the sampling chamber cover by a cap nut. At the lower end of the capillary a precision measuring pore is positioned. The measuring pore has a cylindrical geometry with a diameter to length ratio of 1:1. The axial arrangement of the hole minimizes the risk of blockage and prevents impurities from accumulating inside the capillary body. Precision measuring capillaries with diameters 45 µm, 60 µm, and 150 µm are available to match the requirements of nearly all applications. The lower measuring limit of a measuring capillary amounts to approximately 2% of the capillary diameter.

To change the measuring capillary, first carefully unplug the external electrode. Then release the cap nut and remove it with the measuring capillary by pulling downwards. In order to prevent the measuring capillary becoming contaminated with grease and dust, try to avoid touching its lower end, which is immersed in the sample.

To re-assemble, screw in the cap nut manually (**do not** use a tool). Ensure that the tube extending inside the measuring capillary is not buckled or pinched during assembly. Then, carefully plug in the external electrode, without bending it, and return it to its original position. Step-by-step instructions for changing the capillary can also be found on www.cellcounting.de.

An appropriate template must be selected before the new capillary is used to perform measurements ([7.3.3 Templates](#)). You should also run a background check ([7.1 Background Monitoring](#)).

If you have to change the measuring capillaries several times in one day, store the unused ones in freshly filtered CASYton.



Unused measuring capillaries must always be cleaned thoroughly before being stored. Dried residues in the measuring pore can result in subsequent blockages. This can be prevented by placing the measuring capillaries in CASYclean and leaving overnight. The following day, flush the measuring capillaries carefully using CASYclean and then flush repeatedly with distilled water. Blow the fluid from the measuring capillaries and store in a clean place.



*The measuring capillaries should be cleaned using only the **CASYclean** agent specified by **OMNI Life Science GmbH & Co KG**. Other agents may destroy the measuring capillaries. **OMNI Life Science GmbH & Co KG** is not liable for any damage caused by using alternative cleaning agents.*



*The precision measuring capillaries are individually labeled with serial numbers and must not, under any circumstances, be interchanged between devices. **The calibration certificates apply only if the stated capillaries are used together with the corresponding measuring system.***

3.3 Pressure System and Power Supply

The **pressure system** is accommodated in its own cylinder situated behind the measuring unit (concealed in Figure 6). The no-maintenance vacuum pump, combined with pressure sensors, guarantees that the vacuum required to aspirate the sample remains constant, irrespective of any external pressure. The pressure system also interacts with the valves on the measuring unit to control all fluid movements required to empty the vertical tube, replenish the fluid system and counter-flush the measuring capillary. A schematic diagram of the fluid/pressure system including all valves can be found in [9.1 The Liquid/Pressure System](#).

The **power supply** for the measuring electronics of the CASY system is housed in the cylinder arranged outside to the right (see Figure 6). Special filters ensure that the mains power supply is afforded maximum interference protection.

3.4 Control Device

The CASY can be controlled by computer, notebook or tablet fulfilling the following requirements below. It can be ordered separately through OLS OMNI Life Science or your local distributor.

- + Operating System: Microsoft Windows 10
 - + Windows Fall Creators Update must be installed (at least Windows Version 1709 Build 16299.192)
 - + Net Framework 4.7
- + Additional software requirements
 - + Microsoft Access Database Engine 2010 Redistributable
 - + Attention: In case you want to run Microsoft Office on the same machine, it must be installed in x86-Version
- + At least 4 GB RAM and 20 GB disk space is recommended
- + A dual-core CPU with 2,30 GHz is recommended
- + At least one USB 2.0 (or higher) must be available
- + Screen resolution recommended at least: 1920 x 1080
- + Administrative rights are required to perform software installation and updates

A USB Storage device containing the software to control the CASY instrument will be supplied together with data cable and USB/RS232 adapter to connect the CASY to the Control device. The Control device is not part of the order number of CASY and has to be ordered separately.

4. STARTUP

4.1 Choosing the Location

The CASY is a precision measuring instrument. To ensure fault-free measuring operation, consider the points listed in section **VIII. Warnings and Precautions**. You must choose the location according to the following criteria:

- + Place the instrument on a solid, dry work table that is exposed to neither strong mechanical vibrations nor high-volume noises (e.g., ultrasonic baths).
- + Choose the installation site so that the CASY Instrument is protected from mechanical damage and water and solvent spillage. This applies specifically to the control device.
- + Choose a room that is as smoke- and dust-free as possible and that has a constant room temperature of +15 to +32°C.
- + This instrument has been designed and tested to CISPR 11 Class B. In a domestic environment it may cause radio interference, in which case you may need to take measures to mitigate the interference.
 - + The electromagnetic environment should be evaluated prior to operation of the device.
- + Concerning immunity test requirements, the instrument has been designed and tested for use in controlled electromagnetic environment.
 - + Do not operate this instrument in close proximity to sources of strong electromagnetic fields (for example, unshielded intentional RF sources such as mobile telephones), as these may interfere with proper operation.
 - + For further protection, an uninterruptible power supply (UPS) is recommended, depending upon the quality of electrical grounding of the local electrical power supply.
- + Connect the analyzer to grounded power outlets only (IEC protection class 1).
- + In order to achieve good contrast, avoid placing the CASY System directly in front of a brightly lit window.





To lift and carry the instrument, simply raise it onto the base plate.

4.2 Assembly and Cabling

Connect your CASY System to an interference-free measuring instrument socket. Under no circumstances you should operate the instrument from the same socket as laboratory equipment that works with high switching loads (autoclaves, centrifuges, agitators, etc.). You must also ensure that all laboratory equipment situated in the same vicinity is interference-free/fault-free. The following connection cables and/or control elements must be connected:

- + USB/RS232 adapter and USB cable connecting measurement and control unit
- + Mains power supply cable to the control unit.
- + Sample platform and outer electrode.
- + Protection shield connected to the sampling chamber using the included cable.

 *Never switch on your CASY System unless all elements are correctly mounted and cabled. Before switching on for the first time, ensure that the mains voltage set on the **Voltage Selectors** on the rear of the device are consistent with your mains power supply. If it is necessary to convert the mains power supply, please follow the enclosed installation instructions describing how to change the primary fuses (also see [9.2 Technical Data on CASY](#)). **OMNI Life Science GmbH & Co KG** accepts no liability for damage caused by operating the device from an inappropriate power supply.*

 *To make sure that the instrument is completely shut down when disconnecting the unit again, disconnect the power cable from the power inlet.*

4.2.1 Installing the USB/RS232 Adapter

To enable communication between Measuring and the Control unit a USB/RS232 Adapter needs to be installed. The Adapter, an USB cable and the driver Software are in the accessory box.

Please connect the adapter to the measuring unit and to the Control unit by the USB cable. To install the driver, please insert the driver software and follow the instructions.

4.3 Software Installation

Each CASY is supplied with **Activation keys** that provide one license of CASY software to be installed on the control unit and one additional analytic version that can be installed on another computer. The software tool to install the software, the **Universal Installer**, is provided on an USB Stick in the accessory. Follow instructions below to install CASY software to the Control Device. Make sure the computer matches the requirements as listed in section [3.4 Control Device](#). The control device has to be connected to the internet and to the measuring unit (switched on) before starting the installation.

4.3.1 Software installation

1. Ensure Windows 10 operating system is up to date (Settings -> System -> About)
2. In case update Windows by using Windows 10 Fall Creators Update (<https://www.microsoft.com/de-de/software-download/windows10>)
3. Install CASY Software using the provided Universal Installer
 - a. Installation location default:
C:\Users\[UserName]\AppData\Roaming\Casy
 - b. IMPORTANT: User must have read and write permissions in installation directory**
 - c. A desktop icon will be created by default

When you start the software for the first time, you will be asked to enter the activation key. **Important:** To activate and download your software, you must ensure a stable internet connection is given.

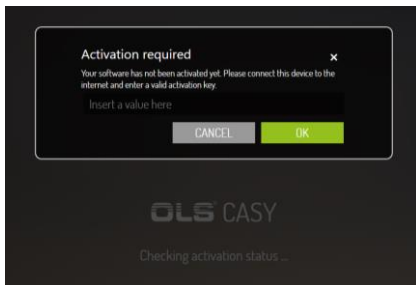



Figure 7: Pop up Screen to enter Activation Key

After entering the activation key the software will validate the key and an automated update process will start. The activation process will further load necessary add-ons and calibration files to ensure proper work of the CASY instrument.

After successful activation of the software, it is not necessary to keep the Control unit online.

 You will only receive updates when your device is connected to the internet and the license has not expired.

 For initial access to a new system, a factory-set **default User** is available. This User has the UserID **“setup”** and the Password **“x”**. It is recommended to generate a new Supervisor PW immediately as described in section [6.2.2 User Management](#).

4.3.2 Special installation steps for Control devices with touch screen

+ It is recommended to disable Edge support (Administrative rights needed). This will avoid opening the action center when swiping in from the right side of your screen.

+ Open the **Local Group Policy Editor (gpedit.msc)**

+ In the left pane of **Local Group Policy Editor**, navigate to the location below. (see screenshot below)

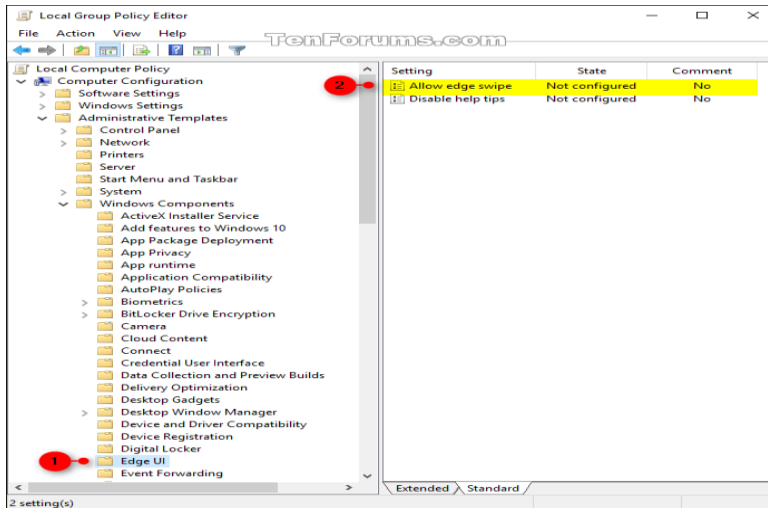

+ In the right pane of Edge UI in Local Group Policy Editor, double click/tap on the Allow edge swipe policy to edit it. (see screenshot above)

+ Select (dot) disabled, click/tap on OK (see screenshot below)

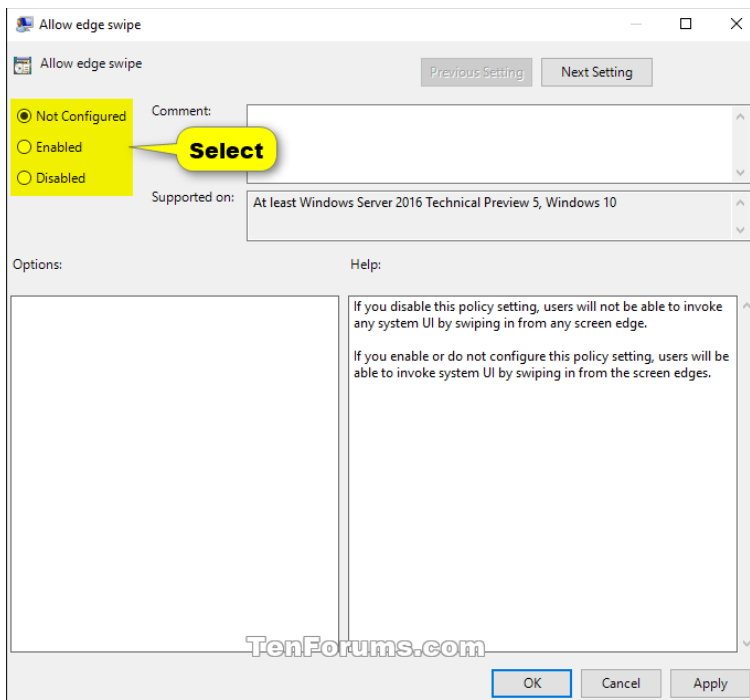

+ When finished, you can close the Local Group Policy Editor if you like.

+ Sign out and sign in to Windows, or restart the computer to apply.

5. MAINTENANCE AND CARE

The CASY System is designed to be low-maintenance; the fluid system, however, requires regular attention to guarantee fault-free work over several years. Remember that you are working with biological material. Residues in the fluid system or growth of bacteria, algae, or yeast cells may lead to blockages in the measuring pore, high background, or other faults during operation. To avoid such errors, you must follow the cleaning procedure described below at least once per week.

The recommended agent, **CASYclean**, is available from **OMNI Life Science GmbH & Co KG**.

! *The system should be cleaned using only the **CASYclean** agent specified by **OMNI Life Science GmbH & Co KG**. Never use aggressive cleaning fluids on the CASY Instrument. **OMNI Life Science GmbH & Co KG** accepts no liability for damage caused by using other cleaning agents!*

CASY software supports maintenance with wizards that will guide through the required steps. All wizard for Maintenance are accessible by clicking in the upper left corner of the software and selecting Service (see Figure 8). A new window with all accessible wizards will appear (see Figure 9)

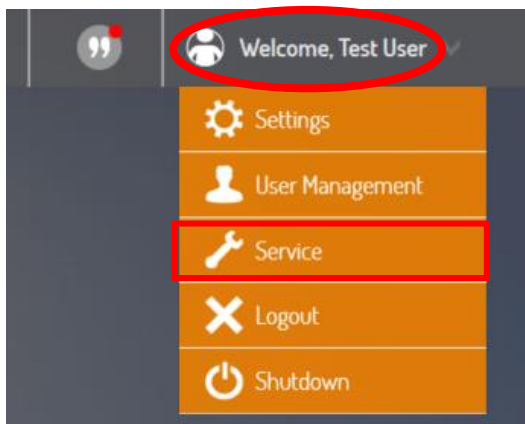

Figure 8: Service Functions accessible in the upper left corner of the software

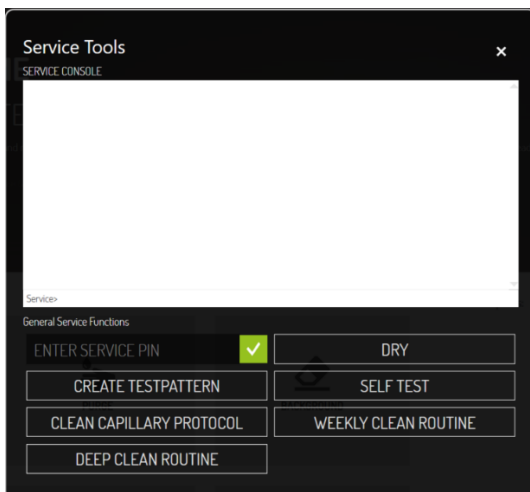



Figure 9: Service Tools

5.1 Weekly Cleaning Wizard

 *Weekly Cleaning should be performed regularly once a week for optimal performance of the instrument. The software keeps record of the last performed cleaning and will remind you in case last cleaning is more than one week ago.*

Weekly Cleaning Wizard is accessible from Service Menu (see Figure 8). Once the wizard has started follow the instructions as displayed on the screen. The Weekly Cleaning Wizard includes an incubation with CASYclean. Once this step is reached, a countdown of one hour will appear, the minimum incubation time. Incubation times can be extended to overnight or over the weekend.

5.2 Clean Capillary Wizard

 *Clean Capillary Wizard can be used in case an increased level of errors is observed caused by blocked capillaries. Before using the routine try to use **Purge** to remove possible blockages! Do **NEVER** try to remove blockages mechanically, i.e., using small needles or comparable tools as it can destroy the capillary!!!*

Clean Capillary Wizard is accessible from Service Menu (see Figure 8). Once the wizard has started follow the instructions as displayed on the screen.

Depending on the status of the capillary the software may ask you to remove the capillary from the instrument and sonicate it for 5 min. For detailed instructions please see section 3.2.

5.3 Deep Clean Wizard

 *Deep Clean Wizard can be used in case of increased impurities inside the instrument. These can be a result of different factors including repeatedly leaving samples in the instrument after usage. Symptoms are usually increased levels of large air bubbles.*

Deep Clean Wizard is accessible from Service Menu (see Figure 8). Once the wizard has started follow the instructions as displayed on the screen.

5.4 Cleaning the Cylinders and the Sampling Chamber

Clean the surfaces of your CASY System regularly using a damp microfiber cloth. It is important to remove salt solution spillages immediately. To do this, raise the sample platform and remove by pulling forwards. 80% ethanol can be used to remove organic impurities. Under no circumstances, however, should other organic solvents be used.

5.5 How to Set the CASY System Out of Operation

In case the CASY System is not going to be used for a longer time (more than two weeks), the fluid system should be drained. Before shutting down, the fluid system must be cleaned (see 5.1, *Weekly Cleaning Wizard*). Follow this procedure to shut down the system:

-
1. Perform Weekly Cleaning Wizard (see section 5.1)
 2. Replace CASYton with distilled water – put two CASYcups with distilled water under the capillary and instead of the CASYton container. Purge 3 times.
 3. Repeat Step 2.
 4. Replace CASYcups with distilled water by two empty cups.
 5. Execute **DRY** from Service menu for two times
 6. Empty the waste container and the two CASYcups.
 7. Switch off instrument and Control Device now
 8. Ensure that the system is adequately protected from dust while it is shut down.

You should begin the **Startup** procedure with the **Weekly Cleaning Wizard**.



You must ensure that when the CASY fluid system contains a saline solution, it is not allowed to dry out. This will prevent malfunction or damage to the fluid system and valves caused by salt crystals.

6. OPERATION OF CASY

Before using the CASY instrument for the first time, the instrument has to be setup and software needs to be installed. For more information see section [4. Startup](#).

6.1 Switch ON / OFF and Login

 Starting CASY requires to switch on the Measuring unit first before starting the CASY software on the Control Device.

Fitted to the rear panel of the CASY System is a green power switch which, when turned to ON, illuminates and indicates that the device is ready to be used. Always switch on the CASY instrument first before starting the CASY Control Software.

 For Control Devices not purchased through OLS OMNI Life Science, installation of the Control Software is required (see section [4.3](#))

After start of the CASY Control Software the instrument will perform a self-test. Hardware, pressure system and Memory will be tested. In case all test are performing OK, a Login Window will pop up allowing the user to login. Additionally there is the option to change the password.

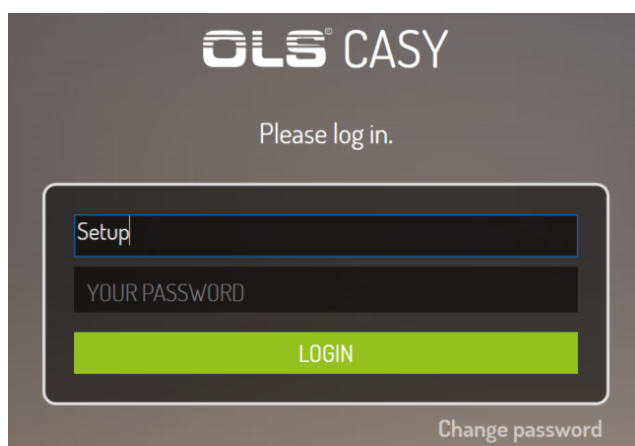



Figure 10: Login Window, allows individual logins for different users

 For initial access to a new system, a factory-set **default user** is available. This user has the UserID "**setup**" and the Password "**x**". It is recommended to generate a new supervisor PW immediately as described in section [6.2.2 User Management](#).

Before switching off the instrument, the background has to be monitored to be Ok. Before switching of the Measuring unit, put a CASYcup with fresh CASYton under the capillary.

6.2 Dashboard and Software Functions

After software is started, the dashboard will appear. It provides easy access to all available functions of the software.

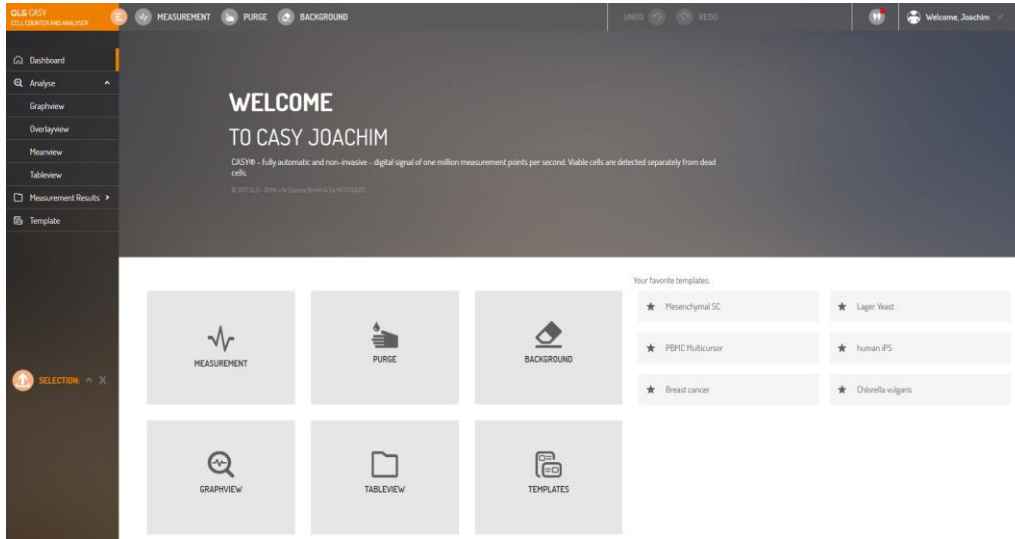
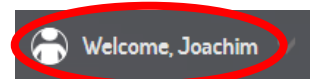

Figure 11: Dashboard allowing fast measurements or access to all relevant functions



Some functions are exclusively related to control of the Measuring Unit. If the connection between Measuring und Control Unit fails or if the Accessory/Desktop Version of the Software is started, those functions are not accessible.

- + **Background** (Button on Dashboard or Top Menu) - used to detect the background level (see section [7.1 Background monitoring](#))
- + **Purge** (Button on Dashboard or Top Menu) - used to purge the instrument with CASYton from the CASYton storage container.
- + **Measurement** (Button on Dashboard or Top Menu) initiates a new measurement
- + **Undo and Redo** (Top Menu) - Allows the Undo or Redo last performed activities in the software
- + **Logged in User** - (Top Menu) provides access to additional functions including
 - + Settings
 - + User Management
 - + Service
 - + Logout
 - + Shut down.
- + **Measurement Results** (left Sidebar) - access to existing results. Also allows import of data to the computer from selected older CASY versions or other CASY instruments.
- + **Analyze** (left Sidebar) - allows analysis of data/measurements that just have been measured or selected in "Measurement results".
 - + **Graph View** - displays results of individual measurements
 - + **Overlay** - will plot the selected measurements in one graph



- + **Mean View** - generates a mean curve / result from the selected measurements.
- + **Table View** - Data of the selected measurements can be analyzed, deleted, customized and exported.
- + **Templates** (left sidebar) - represent the protocol and setting used for measuring specific samples. Templates can be modified, ex- or import and selected as favorites.
- + **Favorite Templates** - once selected as Favorite, those Templates will be shown on Dashboard and allow fast and easy measuring those samples.
- + **Selection** (left sidebar) – lists the selected measurements. The icon enables export of results in CASY format or a raw data.

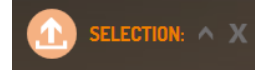

6.2.1 System Settings

System settings (see Figure 12) comprises a number of settings that are relevant to the entire system. It includes setting for languages (also see [6.2.2 User Management](#)), allows to define Annotation Types or to make settings related to automate Backups.

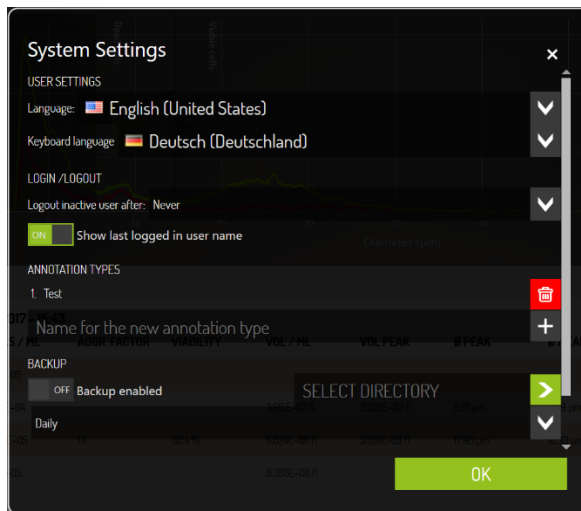

Figure 12: Dashboard allowing fast measurements or access to all relevant functions

- + **USER SETTINGS** - allow to change the language for the software or for the keyboard that is used
- + **LOGIN/LOGOUT** - enables to define how long the CASY can be idle before the current user is logged out or if the last user name shall be displayed in login window.
- + **ANNOTATION TYPES** - additional to the Annotation/Tags that are automatically available in the sidebar in Table View, a supervisor can define customized Annotations. After definition they will appear as part of the options in the right sidebar in table view.
- + **BACKUP** - supervisor can define a directory and a frequency for Backup
- + **DEFAULT FILE PATH** - supervisor can define a default path for im-/export of measurements

6.2.2 User Management

CASY differentiates between three distinct security levels

- + **User** - has the lowest level of rights. Basically users can use predefined templates to measure samples.
- + **Operator** - Additional to the rights of users, operators are able to create new templates or to modify measurements like the settings for cursors
- + **Supervisor** - highest levels of rights. Supervisor are also able to delete measurements or templates. Supervisor are able to create and delete users and to assign the user levels.



Be aware that some functions will not be accessible to all security levels.

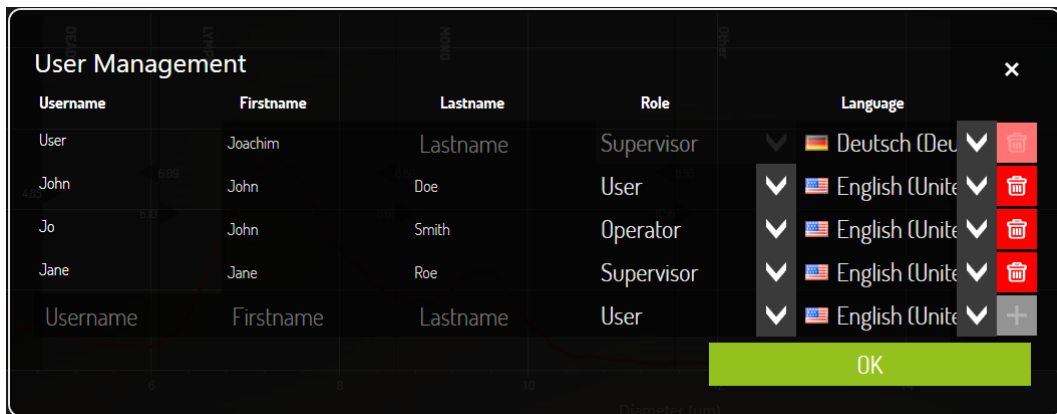

Figure 13: User Management Window allows to generate, delete new users or assign security levels or languages to users.

To generate a new user or to change the settings of an existing User, open User Management (see section [6.2 Dashboard and Software functions](#)). User Management is only accessible for **Supervisors**.

To enter a new user simply fill in the Username, First and Last name, assign a role and language and click on **+** when finished. The first time the new User will try to login he will need to set a password. Depending on the security level right, some program functions will not be available. You can change your **Password** yourself at any time (see [6.1 Switch ON/OFF and Login](#)).



To guarantee the security of both system and measuring data, access data must never be disclosed to third parties. Passwords should never be kept in writing and should be changed on a regular basis.

6.2.3 Emergency Password

In the event that the Supervisor password is lost or cannot be accepted by the system for technical reasons, the Supervisor can use the Emergency Password to get one time access to the Instrument as Supervisor. This will allow to create a new supervisor. To generate an Emergency Password use the **CASY Emergency Password** program which is stored on the USB Stick provided with the instrument. Enter current **Date** and **Session ID** (see login screen), a valid Password is created.

Enter Emergency Password together with User **“Supervisor”** and a one-time access is enable as Supervisor.



Keep the USB stick containing the CASY Emergency Password program in a safe place and ensure that only authorized persons have access to it.

6.3 Service

The **Service** menu (see section 6.2) includes commands required to service the system. Some of the commands are accessible all time, while access to some functions is only possible after entering a valid Service Pin. These additional functions are not part of this manual. Also see section 5.

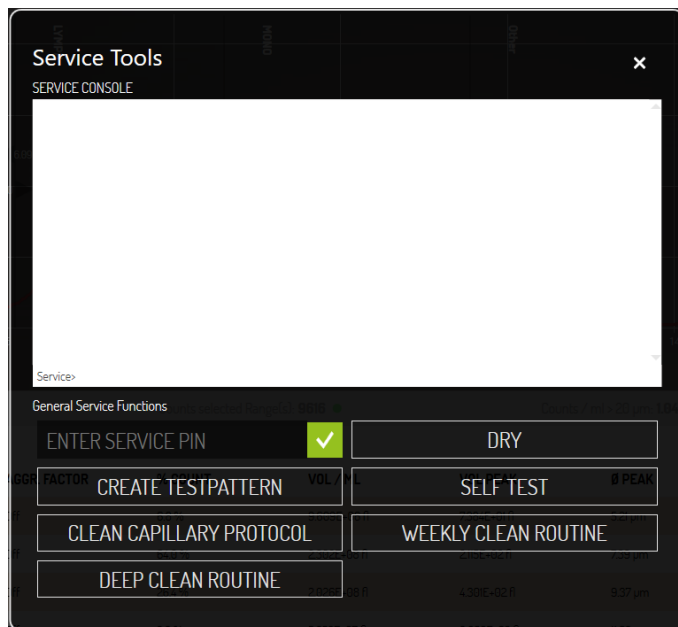

Figure 14: Service Tools window

6.3.1 Service Menu – Dry Liquid System

If you intend to leave your CASY Instrument idle for several weeks, or if you have to send it for service, the liquid system must be drained. Detailed instructions how to set the system out of operation can be found in section 5.5.

The **Dry Liquid System** command completely drains the liquid system and blows air through it for some time. Replace the storage container and the waste container with dry vessels. Repeat the process until no further liquid is blown out.

⚠ Before you use the **Dry Liquid System** command, ensure that your CASY Instrument has been carefully cleaned (see 5.1 *Weekly Cleaning Wizard*) and contains no saline solution. Complete the cleaning procedure by flushing with distilled water. Biological deposits and salt crystals that dry inside the measuring pore may result in the system becoming permanently clogged.

6.3.2 Start Self-Test

This command starts the **Self-Test** for the measuring system, which is also executed during the startup process. The following checks are carried out:

- + Check of the 12V and 24V voltage supply to the measuring electronics.
- + Check of the real-time clock in the measuring electronics.
- + Check of program and working memory in measuring electronics.
- + Check of pressure system to ensure tightness.

6.3.3 Generate Test Pattern

The **Generate Test Pattern** feature creates a defined size distribution and performs a standardized data evaluation using specified parameters. A test printout marked **Standardized Test Pattern** is provided with your device documentation. This test printout was produced during the final factory check of your device and forms the basis for comparison with all subsequent checks.

6.3.4 Enter Service PIN

Enter Service PIN allows activating commands of the integrated service module. In case of troubles with your CASY system, the responsible service partner may tell you the **Service PIN**, a numerical code valid for the actual day. The additional service commands enable direct communication with the measuring unit in a service situation. **This option may only be used by authorized, skilled personnel or under the instruction of such persons!**



*Incorrect use of advanced service commands may result in the system becoming permanently damaged! **OMNI Life Science GmbH & Co KG** is not liable for any damage caused by the incorrect operation of these functions!*

6.3.5 Weekly Cleaning Wizard

See section 5.1

6.3.6 Clean Capillary Wizard

See section 5.2

6.3.7 Deep Clean Wizard

See section 5.3

7. PERFORMING AND EVALUATING MEASUREMENTS

Performing measurements requires settings that need to be entered before. In regular use, these settings will be stored in sample specific **Templates** and measurements can be started by two clicks. If no suitable **Template** is available, it needs to be generated as described in this section.

The CASY is factory-calibrated for common cell culture media. Preparation is therefore limited to the following steps:

- + Replenishing the storage container with clean CASYton and emptying the waste container.
- + Adjusting the required measuring capillary if necessary (see section 3.2).
- + Positioning the protection shield for each measurement (see section 4.2).
- + Monitoring the background (see section 7.1).

The background of the CASY System should be monitored at regular intervals. Problems resulting from choosing an unsuitable location or relating to impurities in the system manifest themselves in a high background.



To guarantee that the CASY cup is fixed, rotate the sample platform so that the recess is no longer pointing forward. This secures the cup

7.1 Background monitoring

The background of the CASY System should be monitored at regular intervals. Problems resulting from choosing an unsuitable location or relating to impurities in the system manifest themselves in a high background.

After clicking the Background - button a wizard will open, guiding through the required steps. At the end the result will be displayed (see Figure 15). A colored signal indicates the result. If the signal is **red** or **orange** it is recommended to **REPEAT** the measurement. After each REPEAT the CASYcup should be replaced by a new one with freshly filtered CASYton.

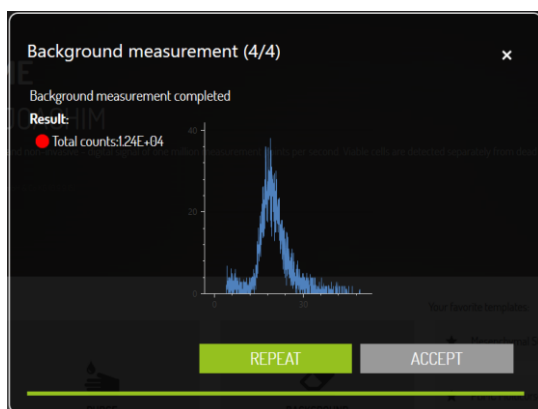

Figure 15: Result of Background measurement. In this case the red signal indicates too high background levels.

Depending on the capillary used, the background should not exceed the following values:

-
- + 150 µm measuring capillary: < 100 Counts/ml
 - + 60 µm measuring capillary: < 200 Counts/ml
 - + 45 µm measuring capillary: < 3000 Counts/ml

If the system fails to become clean even after several **REPEATS**, you should carry out the Weekly Cleaning Wizard as described in section 5.1.



You must ensure that all vessels used to prepare the samples, the CASYton used to flush the system and dilute the samples, and also any CASYcups used, are virtually free of grease and particle impurities. For routine preparation of the measuring samples, use a dispenser (10 ml) with a filter attached to the outlet. A pore size is suitable to be used independent of the capillary.



To avoid incorrect measurements, CASYcups should be used only once.

7.2 Preparing Samples

- + Fill a CASY cup with 10ml filtered CASYton.
- + Add an aliquot of the cell suspension to be examined (normally between 10µl and 200 µl).
- + Secure the lid and mix the sample by tilting the CASY cup three times, carefully avoiding the formation of bubbles or foam.



Your CASY System can measure only the samples you provide. The quality of the measuring result depends on how well you prepare your samples. Standardize the sample preparation procedure as much as possible (media, timing of sample preparation, duration and intensity of cell re-suspension, carrying out the required dilution steps, etc.).

Freshly prepare your samples just before the measurement. Depending on the sensitivity of the cell type, there is no guarantee that your cells in CASYton will remain unchanged in terms of cell count, cell volume, aggregation, and viability over long periods. If a sample remains in CASYton for longer than two minutes, you must remix it before the measurement.

Always use new CASYcups. This prevents high background caused by contaminated measuring cups.

7.3 Measuring Samples and Displaying the Size Distribution

- + Rotate the recess in the sampling platform until it points forward and remove the CASY cup from below the measuring capillary.
- + Place the sample to be measured below the measuring capillary and ensure that the external platinum electrode is immersed in the sample.
- + Rotate the sampling platform somewhat to the side again.
- + Place the protection shield around the sample platform, including the capillary and the external electrode, by pushing it completely to the wall of the sample chamber.
- + Press **Measurement**, select **Template** and press **Measure** to perform a measurement. For following measurements the last used template is preselected. In case no Template is available, refer to section [7.3.3 Templates](#)
- + If a Template has been selected as favorite it will appear on dashboard and a measurement can be started directly from there.
- + The CASY System automatically works through all the necessary steps. During the measurement, a status dialogue is displayed telling you which measuring cycle has just been performed.
- + After a short time, the size distribution and the numerical results for your sample appear in the display.
- + Measurements can be analyzed in **Viability** and in **Free Cursor** Mode. How to use both will be described in section [7.3.4 Cursor Settings](#). Using the settings button allows to switch between the two modes

7.3.1 Measurements

Measuring a sample using an existing template can be done by clicking on “Measure”. Next a pop up will appear containing all existing templates (see Figure 16). The template that has been used most recently is preselected. To select another one, just click on the corresponding template. Clicking on “Measure” will start the measurement. After the measurement is finished the result will be displayed in Graph View (see Figure 17).

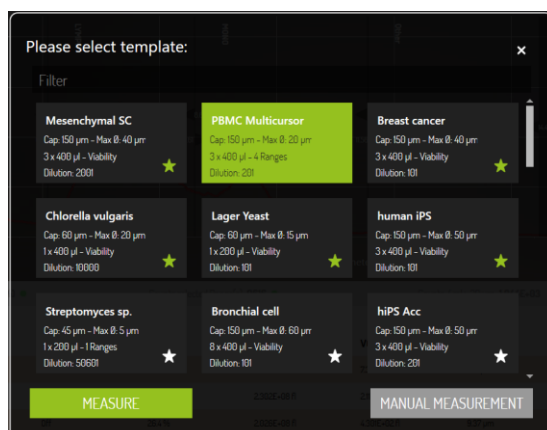

Figure 16: Template window opens after clicking on Measurement. A Template can easily be chosen and the measurement started

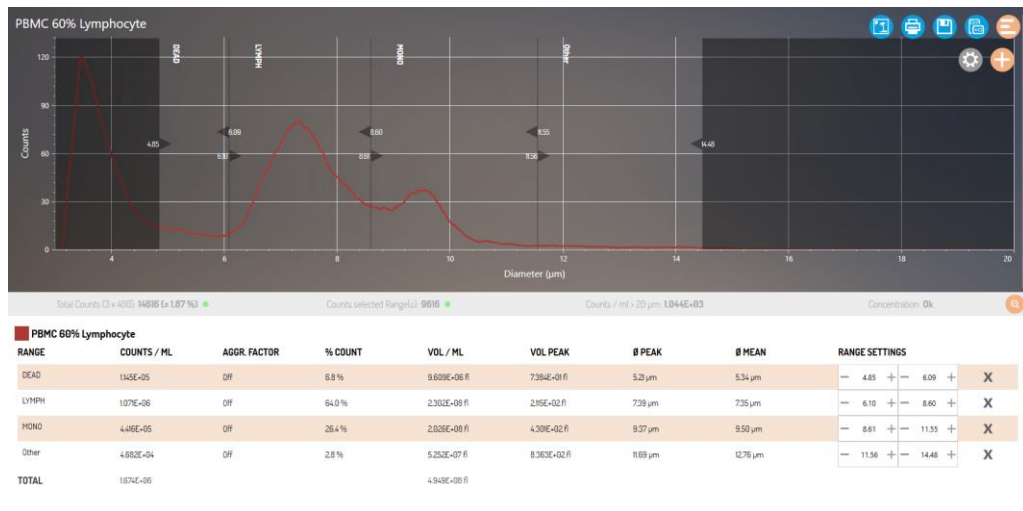
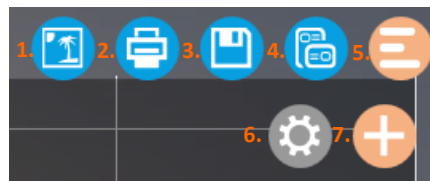

Figure 17: Result of PBMC- Measurement in Graph View. Four independent Cursors have been set to differentiate between cell populations. Details are displayed below the graph. The curve has been smoothed.

7.3.2 Options for Measurement results

Once a measurement is finished, there are several options to continue working with the result:



1. Save the graph
2. Print – will generate a report in PDF version. Enable printing reports
3. Save Measurement– store the measurements
4. Save Template –current settings will used to create a Template
5. Hide/Show Options
6. Measurement Settings – make changes to settings related to specific results
7. Add Cursor – in free ranges mode up to 5 independent cursor ranges can be defined

7.3.3 Templates

Templates represent the measurement method. This means they contain all parameters a CASY uses to analyze a specific sample. Consequently they are sample specific. Templates can be created in different ways.

1. Templates can be imported or exported (see Figure 18)
2. Templates can be created:
 - + Click **Manual Measurement** (see Figure 16) and a new window will open (see Figure 19)
 - + Select **Capillary** (if available)
 - + Select **Size** range. (It is recommended to select an x-size scale that is about 2 to 3 times of the size of the peak diameter)
 - + Select **Cycles**
 - + 150µm capillary - 3 cycles with 400µl is recommended
 - + 60µm and 45µm capillary - 1 cycle with 200µl is recommended.
 - + Choose between **Viability and Free Ranges** mode
 - + **Viability** – will provide a pair of cursors, one to define the dead and one to define the viable cells
 - + **Free Ranges** – allows to define up to 5 different ranges that will be analyzed.
 - + Enter **Dilution** or the volume of sample added to 10ml of CASYton.
 - o Dilution is recommended to result in the following concentrations for optimal results:
 - 150µm > 2.000 and < 20.000 counts/ml
 - 60µm > 4.000 and <100.000 counts/ml
 - 45µm > 20.000 and <200.000 counts/ml
 - + Click **Measure**
 - + Check measurement result and make adjustments to settings if necessary. When satisfied with settings generate template by clicking on **Create Template** (see 7.3.2)

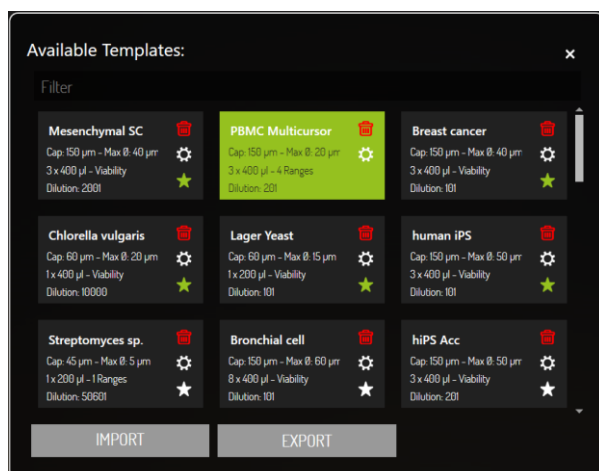

Figure 18: Template function – all templates are displayed. Templates can be import or exported, deleted or modified.

Please select the required parameter for the measurement: ✕

150 μm ▼ 40 μm ▼

CYCLES 3

VOLUME 200 μl 400 μl

MODE Viability Free Ranges

DILUTION

Factor 101

Sample Volume (μl) 100

Volume CASYton (ml) 10

MEASURE SELECT TEMPLATE

Figure 19: Manual measurement allows to measure samples without existing Template

⚠ When the result is displayed it may be necessary to adjust some of the parameters above and repeat the measurement to receive optimal results. When the results meets the above mentioned requirements continue with [7.3.4 Cursor Settings](#).

7.3.4 Cursor Settings

There are two modes for setting cursors – “**Viability**” and “**Free Ranges**”. For each cell type the cursors need to be adjusted individually in the template.

- + **Free ranges** can be used to analyze various kinds of samples including heterogeneous samples, e.g. contain different cell types.
 - + Up to 5 different cursor ranges can be added.
 - + Cursor can be added by clicking on +
 - + Cursor can be adjusted directly in the graph or through the “-“ or “+” keys in the measurement data.
 - + To remove a cursor, click on the “x” behind the cursor details

- + **Viability Mode** for eukaryotic cells contains two cursor regions (see section 2.3) – one for dead and one for the viable cells. To identify the size in which the dead cells peak, viable cells can be incubated with CASYblue.
 - + After the sample has been measured and suitable size range and dilution are identified (see section 7.3.3), it is recommended to incubate the same volume of sample with 4 to 5 times access volume of CASYblue for 2min before diluting with 10ml of CASYton.
 - + Measure the sample with pretreated cells and save the result.
 - + Using an **Overlay view** of the viable and the CASYblue pretreated cells enable to easily define the cursor for the specific cells type (see figure 20)
 - + After the cursors have been adjusted the settings can be stored to the template by clicking on the corresponding icon

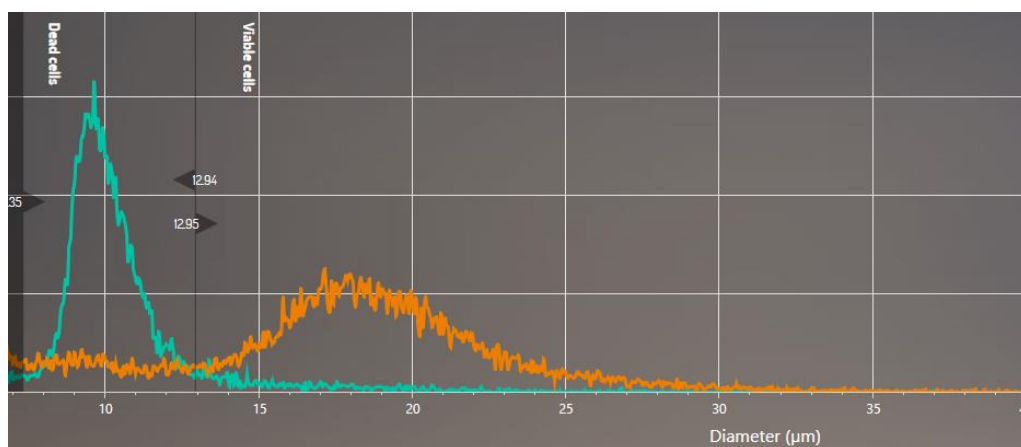

Figure 20: Overlay of pharynx cancer cells. Orange – viable cells; green – viable cells pretreated with CASYblue

7.3.5 Aggregation correction

The CASY software offers 3 Modes to handle aggregation of cells. For details about the principle please refer to section [2.4 Aggregation Correction](#).

The settings for aggregation correction can be adjusted for single measurements in Graph View or for several measurements at the same time in Overlay View. The settings are accessible under **Measurement Settings** (see Figure 21). Please note that “**From Parents**” is only available in Overlay view. The settings can be stored in Templates and will be automatically used for new measurements with the corresponding template.

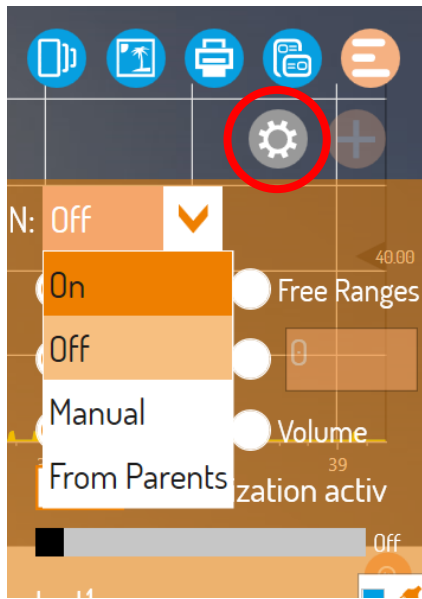

Figure 21: Options for Aggregation correction in Overlay View.

- + ON – will switch on aggregation mode on in automatic mode as described in section 2.4
- + OFF – is the default setting and aggregation correction is switched off
- + Manual – in some cases like low concentrated samples, using manual mode will improve results. In this mode, the volume for the average cell is entered and stored by the user. The value can be taken from previous measurements.
- + From Parents – (only in Overlay View) allows to maintain individual settings from results analyzed in the overlay.

7.4 Points to be Observed When Performing Measurements

For measuring operation, use only **CASYton**, **CASYcups**, and **CASYclean** as specified by **OMNI Life Science GmbH & Co KG**. The use of alternative measuring solutions, cups, and cleaning agents may lead to incorrect measuring results and cause damage to the fluid system of the CASY Instrument. **OMNI Life Science GmbH & Co KG** accepts no liability for damage caused by using alternative consumables.

A smooth measuring operation depends on the system undergoing the regular **Weekly Cleaning Routine** using **CASYclean**.

You must ensure that your CASY System is kept clean between cleaning cycles specifically that cells never remain in the fluid system for long periods. The daily **Background Monitoring Procedure** and the visual check of the vertical tube will indicate when the system is becoming contaminated.

The vertical tube is a calibrated glass pipette through which the CASY System, controlled by a light barrier, aspirates the set measuring volume. The vertical tube is visible in the inspection window at the front of the measuring unit. During the measurement, you can visually track the rising level of the fluid meniscus. Depending on the level in the vertical tube, one or several light diodes (**Green** = start of measurement, **Red 1** = 200 µl measuring volume, **Red 2** = 400 µl measuring volume) illuminates. Judge the status of the vertical tube as you would a glass pipette. If you see that the fluid is no longer running cleanly and drops of fluid remain suspended on the edge, the calculation of your sample concentration may be adversely affected. In such cases, run a cleaning cycle using **CASYclean**.

7.4.1 Changing the Samples

Provided you measure samples of the same cell type in a similar concentration range, you do not have to flush the system when the samples are changed. If desired, you may rinse the surface of the capillary and the outer electrode by inserting a CASY cup containing freshly filtered **CASYton**, without triggering a cleaning cycle. If you expect larger concentration differences or wish to perform measurements with a different sample type (*e.g.*, another cell type), before a new measurement, place a CASY cup containing clean **CASYton** below the measuring capillary and flush the system using the **Purge** function.

7.4.2 Sample Concentration

For correct measuring results, the concentration of the diluted cell suspension in the CASY cup should not exceed certain maximum values. This concentration limit depends on the size of the measuring capillary:

150 µm measuring capillary:	<20 000 counts/ml
60 µm measuring capillary:	<100 000 counts/ml
45 µm measuring capillary:	<250 000 counts/ml

Higher concentrations than specified result in **coincidence errors** (*i.e.*, an increased probability that two particles will be in the measuring pore at the same time). The CASY Instrument will evaluate two particles being in the measuring-pore at the same time as if they were one particle with a correspondingly larger volume. The calculated particle count will therefore be too low and the size distribution will shift towards the larger volumes.



The coincidence limits do not depend on the positions of your evaluation cursor settings. They are always determined over the entire physical measuring range of the used measuring capillary (approximately 2% to 80% of the measuring-pore diameter). In the case of cell samples, this includes cell debris as well as cell aggregates with a diameter above the scaling range selected for the size axis (X-axis). This guarantees that the cell count and cell volume are always measured correctly.

7.4.3 Measuring Pore Blockages

During the measurement, the CASY System exactly monitors the rise times of the fluid column. This procedure ensures the reliable detection of even film-like deposits (protein, lipids) etc. in the measuring pore, which shrink rather than actually block the pore, resulting in incorrect volume calculation. If the rise time exceeds a critical limit, an error message will appear.

Most blockages occurring during the measuring operation result from the temporary presence of very large particles (e.g., aggregates, tissue remnants) in front of the measuring pore, which act like a “valve flap.” You can repeat the measurement immediately after confirming the error message by pressing OK. Shaking the CASY cup slightly often helps to remove contamination from the outside of the measuring pore. If the blockage remains, you can usually remove the contamination easily using the **Purge** function. In case the blockage it is recommended to clean the capillary using the **Clean Capillary Wizard** (see section 6.3)



*During the **Purge** cycle, fluid is flushed under pressure from inside the measuring capillary through the measuring pore into the sampling cup. To prevent your sample becoming diluted or contaminated, replace it with a CASY cup containing freshly filtered CASYton before you run a **Purge** cycle.*



*You will see the **Measuring Timeout** error message even if the fitted measuring capillary has a smaller pore diameter than the measuring capillary entered into the active setup. Always ensure that only setups for the fitted capillary are selected.*

7.4.4 Air Bubbles

The CASY Instrument precisely monitors the incidence of “critical” air bubbles in the rising fluid column within the vertical tube. Large air bubbles affect the accuracy of the sample volume measurement and may result in the cell concentration being measured incorrectly. If an air bubble exceeds a critical size during a measurement, the following error message appears: Large Air Bubble detected

If you observe the vertical tube in the inspection window at the front of the measuring unit, you will be able to see the air bubble. If the air bubble rises to the fluid meniscus and disappears, it will not affect subsequent measurements. You can repeat the measurement immediately after confirming the error message by pressing **OK**. If, however, the air bubble remains suspended in the vertical tube, you must remove it by replenishing the fluid system using the **Purge** flushing function.

Deposits within the fluid system sometimes become noticeable through frequent air bubble error messages. If necessary, run a **Weekly Cleaning Wizard** or, in case this does not help the **Deep Clean Wizard**.



If, during the measurement, only small air bubbles are evident within the vertical tube, no action is necessary. Small air bubbles – which are higher in number using small capillaries – are caused by the process of electrolysis at the inner electrode. These are quite normal; no error message is triggered and the measurement is not affected.

7.4.5 Empty Storage Container

Should the CASY System fail to completely replenish the fluid system during a Purge cycle, the following error message appears: PR8

Ensure that there is sufficient CASYton in the storage container (right-hand container). Replenish the CASYton if necessary and run another **Purge** cycle. If the error message reappears, even when the storage container is sufficiently full, the pressure system may be malfunctioning or the internal tube system is blocked. In this case, contact **OMNI Life Science GmbH & Co KG**.

7.4.6 Measuring Time Too Short

The error message **Measuring Time too short** will be displayed if time for measurement is too short. One reason can be that a capillary is selected in the software, but a different one is installed. Another reason could be that the instrument has not been cleaned properly and requires to perform the weekly cleaning wizard.

If this message still appears when the correct template/capillary is selected and cleaning did not solve the problem, contact OLS for technical support.

7.4.7 Interrupting the Measurement

You can interrupt a measurement at any time. Click **Cancel** in the measurement status display.

7.5 Measurement results

7.5.1 Opening Measurement results

Individual measurement results can be viewed in Graph view. They will automatically be displayed after a measurement is finished. Stored results can be opened by clicking on measurement results.

Stored results can be segmented grouping them in specific “**Experiments**” and “**Groups**”. It is recommended using these classifications to organize the results. To display a result simply click on it once. Clicking a second time will close the measurement. In case all results from an Experiment or Group shall be displayed simply click on the icon in the top line of the pop up. All open measurement results will be displayed under “selected” in the left sidebar. To close a measurement simply click on the **X** beside the name of the measurement.

7.5.2 Overlay & Mean View

Once measurement results have been selected, they can be displayed in an overlay by clicking on **Overlay view** in the left side bar. To be displayed in one overlay, the measurements need to be generated using the same measurement parameters.

If the selected results have different cursor settings, a window will pop up and ask which of the existing cursor settings shall be applied in the overlay.

- + In **Overlay view** results can not only be compared to see slightest changes in size distribution.
- + It is also possible to make adjustments in “Settings” and to store these to all selected measurement results **Save to all**.
- + Overlay will only be available if critical parameters, like capillary or x-scale, used to measure the samples are identical

To generate a **Mean view** it is necessary that all parameters of the selected results, including x-scale, cycles, dilution, etc, are identical. Beside the Mean Curve (bold) also the “mother curve” are displayed. In the result section the deviation for the selected results is displayed.

Mean results can be stored and used to compare experimental result son the level of replicates.

7.5.3 Table view

The “**Table view**” (see Figure 22) allows to display all data that are related to the selected measurement. After clicking on “Table view” a chart will be displayed. Two standards sets of data can be selected.

- + Sets of data can be customized by drag and drop with the right side bar
- + The check box enable to select results for further options:
 - + Trash bin – allows to delete results
 - + Printer – allows to print results
 - + Export – allows to export data to be opened in other software

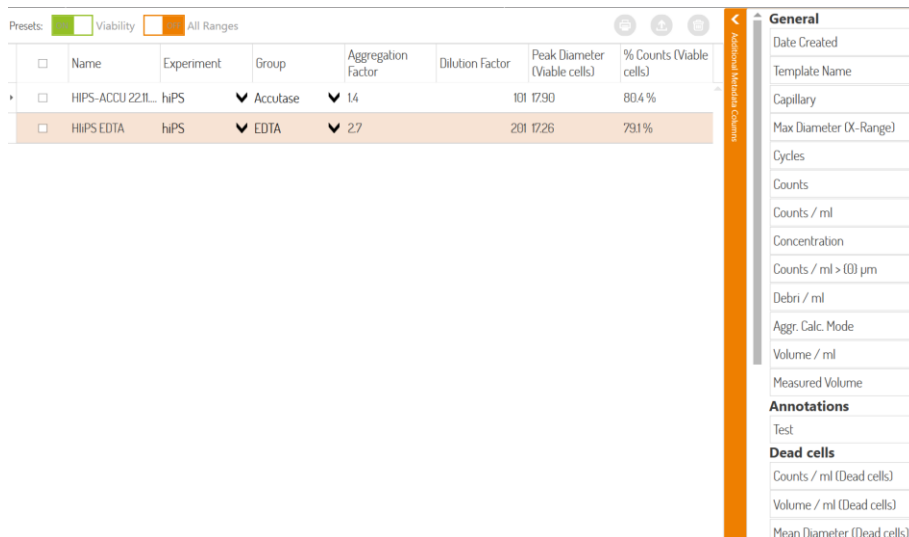

The screenshot shows a software interface with a table of measurement data and a sidebar on the right. The table has columns for Name, Experiment, Group, Aggregation Factor, Dilution Factor, Peak Diameter (Viable cells), and % Counts (Viable cells). Two rows are visible: 'HIPS-ACCU 221L...' and 'HIPS EDTA'. The sidebar on the right is titled 'General' and contains a list of parameters such as Date Created, Template Name, Capillary, Max Diameter (X-Range), Cycles, Counts, Counts / ml, Concentration, Counts / ml > (0) µm, Debris / ml, Aggr. Calc. Mode, Volume / ml, Measured Volume, Annotations, Test, Dead cells, Counts / ml (Dead cells), Volume / ml (Dead cells), and Mean Diameter (Dead cells).

<input type="checkbox"/>	Name	Experiment	Group	Aggregation Factor	Dilution Factor	Peak Diameter (Viable cells)	% Counts (Viable cells)
<input type="checkbox"/>	HIPS-ACCU 221L...	hiPS	Accutase	14		101 1790	80.4 %
<input type="checkbox"/>	HIPS EDTA	hiPS	EDTA	2.7		201 1726	79.1 %

Figure 22: Table View

7.5.4 Importing Measurement results

The arrow down button in Measurement results allows to import data into the software. Data that can be imported includes measurements in .csy Format (actual software) as well as measurements from CASY TTC and TT.

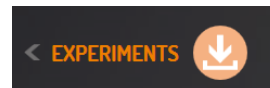

7.5.5 Exporting Measurement results

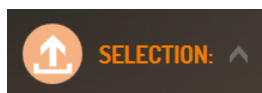

Data can be exported as **CASY data** or as **Raw data**. To export data click the arrow key beside “SELECTION” in left side bar

- + Select the files that shall be exported and click “**Next**”
- + A new window will pop up allowing to choose between **CASY** or **Raw data** format
- + Select where the export shall be saved and in case of more than one result if they are to be saved in one or several files.

8. TROUBLESHOOTING

Points to be considered when performing measurements were already discussed in previous sections 7.4. Additional information can be found on the website under www.cellcounting.de. If you cannot solve the problem using the answers given in this section, contact your OLS representative for troubleshooting assistance.

9. Appendix

9.1 The Liquid/Pressure System

The CASY fluid/pressure system consists of a high-quality, maintenance-free vacuum pump (1), the pressure vessel (4) to buffer high and low pressure, the pressure sensor (8), and a number of special long-life valves. The vertical tube with a total of 4 light barriers for the monitoring and control of fluid movements is an integral part of the fluid system.

The diagram below provides an overview of the structure and function of the fluid/pressure system of the CASY Instrument. Depending on the settings of Valve 5 and Valve 3, the pump (1) creates a high or low pressure which is buffered by the pressure vessel (4). Valve 9 applies the high/low pressure to the external fluid system. Depending on the setting of valves 18 (**Waste Valve**) and 19 (**Clean Valve**), the following fluid movements occur:

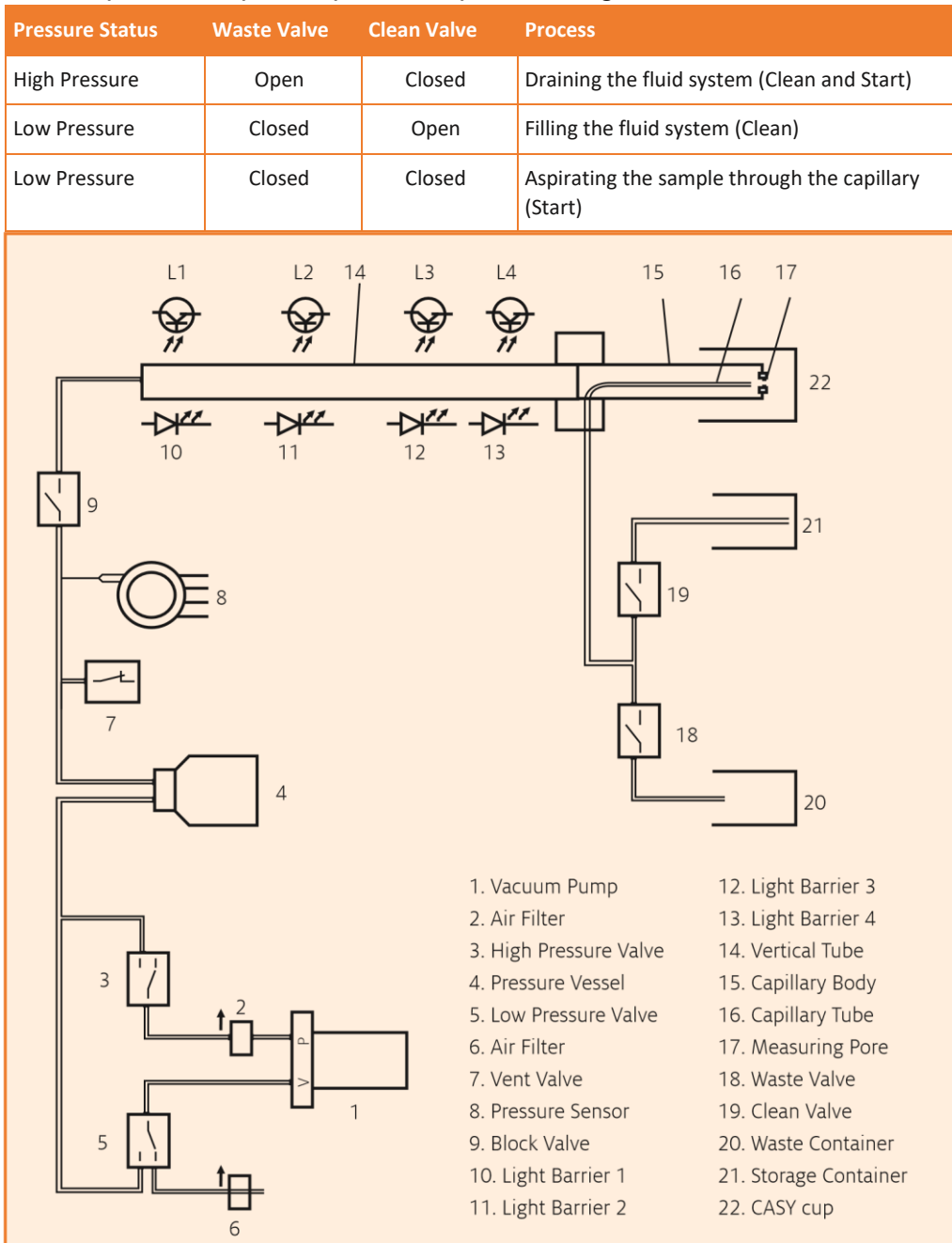

Technical Data CASY

9.2 Technical Data on CASY

Function:	Electronic Cell Counter & Analyzer System for determining cell count and cell size distributions, aggregation, and viability.
Operating Environment:	Indoor use only.
Operational Altitude:	Up to 2000 m above sea level.
Dimensions:	Height: 39 cm Width: 31 cm Depth: 39 cm
Weight:	19 kg
Ambient Conditions:	Maximum operating temperature: +10 to +40°C Recommended operating temperature: +15 to +32°C Operating humidity: 30% to 80% relative humidity (non-condensing)
Power Supply:	230 V ~ +/- 10%/50 Hz 115V ~ +/- 10%/60 Hz
Power Consumption:	60 VA
Fuses (Primary):	Measuring Unit 230V: 2 × 800 mA 115V: 2 × 1.6 A
Fuses (Secondary): (Analyzer Unit)	SI1: T 160mA SI2: T 1.6A SI3: T 400mA SI4: T 2.5 A SI5: T 400mA
Installation Category:	II (according to IEC 61010-1)
Volume Measuring Tube and Pressure System:	Calibrated, opto-electronically controlled volume measuring tube with no-maintenance, sensor controlled pressure system. Mercury-free.
Measuring Principle:	Electrical resistance measurement in 1 MHz low voltage field using Pulse Area Analysis . Distinguishable measuring channels: > 512.000.
Volume Resolution:	1 in 512,000
Displayed Size Channels:	1024
Measuring Range:	0.7 µm to 120 µm (depending on the used measuring capillaries)
Measurement Dynamics:	Ratio of smallest to largest particles that can be analyzed simultaneously: > 1 : 70,000 in terms of volume, > 1 : 40 in terms of diameter.
Typical Analysis Time:	10 seconds
Typical Sample Volume:	10 µl – 100 µl
Measuring Volume:	200 µl – 3.6 ml
Pollution Degree:	2 (according to IEC 61010-1)

Analysis/Results	<p>High resolution size analysis with 1024 displayed size channels. Precise analysis of the concentration and volume of cells and particles using up to five adjustable cursor pairs.</p> <p>The size distribution can be shown as count or volume distribution.</p> <p>Cell count: Absolute, relative -%-</p> <p>Cell viability: Absolute, relative -%-</p> <p>Cell aggregates: Aggregation factor, aggregation correction</p> <p>Cell volume: Volume, mean volume, total volume (biomass)</p> <p>Cell debris: Absolute (optional)</p> <p>%Counts: Percentage evaluation of partial ranges of the size distribution</p> <p>%Volume: Percentage evaluation of partial ranges of the size distribution, and many derived values such as standard deviations etc.</p>
Control Unit	<p>Win based computer or Touchpad</p> <p>Operating system: Windows 10</p>
Interfaces	<p>Analyzer unit: RS232 (DB9)</p>
Technical Features	<p>Permanent, highly stable calibration for biological media – certified by OMNI Life Science GmbH & Co KG, identical for all CASY Systems.</p> <p>High data security provided through special Secure Property File format with internal checksum monitoring.</p> <p>Integrated system self control device with:</p> <ul style="list-style-type: none"> + Recordable system self test, checking all measuring-specific parameters before and after the measurement. + Electronic monitoring of the measuring pore. + Automatic detection and display of operating and system errors. + Test routines for checking the internal signal/data processing from the sensor to the display and the interfaces used for data export. <p>Documentation and management of all user and cell-specific device settings in template files, which can be loaded.</p> <p>Depending on configuration, the device can satisfy the FDA requirement 21 CFR Part 11 for closed systems.</p> <p>The device is fanless (suitable for clean room operation depending on control unit configuration).</p>
Maintenance	<p>If cared for on a regular basis, the CASY System is virtually maintenance free. The system should be cleaned using only the CASYclean agent. The surfaces of the CASY System (cylinders and sampling chamber) should be cleaned regularly using a damp microfiber cloth and 80% ethanol. If a service is necessary or requested by the user, contact OMNI Life Science GmbH & Co KG. Servicing work may only be carried out by engineers who have been trained and approved by OMNI Life Science GmbH & Co KG.</p> <p>We recommend that owners keep the packaging in case the CASY Instrument must be transported.</p>

CASY is registered trademarks of OMNI Life Science GmbH & Co KG.

OMNI Life Science GmbH & Co. KG
Karl-Ferdinand-Braun-Straße 2 28359 Bremen

T +49 421 276 16 9-0 F +49 421 276 16
9-19 info@ols-bio.de www.ols-bio.de
www.cellcounting.de

